

230407

OCALA ELECTRIC UTILITY  
OCALA, FLORIDA

FIRST REVISED SHEET NO. 19.0  
CANCELS ORIGINAL SHEET NO. 19.0

**APPLICATION FOR INTERCONNECTION OF  
CUSTOMER-OWNED RENEWABLE  
GENERATION SYSTEMS**

- TIER 1 - Ten (10) kW or Less
- TIER 2 - Greater than 10 kW and Less Than or Equal to 100 kW
- TIER 3 - Greater than 100 kW and Less Than or Equal to Two (2) MW

Note: These customer-owned renewable generation system size limits may be subject to a cumulative enrollment limit on net-metering customers located in the area served by the City of Ocala Electric Utility. Please refer to the Ocala Electric Utility Net-Metering Rate Schedule.

Ocala Electric Utility customers who install customer-owned renewable generation systems (RGS) and desire to interconnect those facilities with the Ocala Electric Utility system are required to complete this application. When the completed application and fees are returned to Ocala Electric Utility, the process of completing the appropriate Tier 1, Tier 2 or Tier 3 Interconnection Agreement can begin. This application and copies of the Interconnection Agreements may be obtained at Ocala Electric Utility, located at 201 SE 3rd Street, Ocala, Florida 34471, or may be requested by email from OEU@ocalafl.org.

**1. Customer Information**

Name: Virginia Delabarrera/Michael Mccade

Mailing Address: 5640 SE 2nd St

City: Ocala State: FL Zip Code: 34480

Phone Number: 352-425-8146 Alternate Phone Number: \_\_\_\_\_

Email Address: vymccabe@gmail.com Fax Number: \_\_\_\_\_

Ocala Electric Utility Customer Account Number: 530802-138937

**2. RGS Facility Information**

Facility Location: 5640 SE 2nd St Ocala FL 34480

Ocala Electric Utility Customer Account Number: 530802-138937

RGS Manufacturer: Hanwha Q.Cells

Manufacturer's Address: 400 Spectrum Center Dr. Suite 1400 Irvine, CA 92618

Reference or Model Number: Q.PEAK DUO BLK ML-G10+ 400W

Serial Number: 201922321578403041

(Continued on Sheet No.19.1)

Issued by: Michael Poucher, P.E.  
Electric Utility Director

Effective: October 1, 2019

Ocala Electric Utility  
 Ocala, Florida  
 (Continue from Sheet No. 19.0)

FIRST REVISED SHEET NO. 19.1  
 CANCELS ORIGINAL SHEET NO. 19.1

### 3. Facility Rating Information

Gross Power Rating: 9.86 (“Gross power rating” means the total manufacturer’s AC nameplate generating capacity of an on-site customer-owned renewable generation system that will be interconnected to and operate in parallel with Ocala Electric Utility’s distribution facilities. For inverter-based systems, the AC nameplate generating capacity shall be calculated by multiplying the total installed DC nameplate generating capacity by 0.85 in order to account for losses during the conversion from DC to AC.)

Fuel or Energy Source: Solar Photovoltaic

Anticipated In- Service Date: 9/16/2022

### 4. Application Fee

The application fee is based on the Gross Power Rating and must be submitted with this application. The non-refundable application fee is \$375 for Tier 2 and \$750 for Tier 3 installations. There is no application fee for Tier 1 installations.

### 5. Interconnection Study Fee

For Tier 3 installations, a deposit in the amount of the estimated costs of the study (to be determined at time of application) must be paid along with this application in addition to the application fee referenced in Article 4 above. This deposit will be applied toward the cost of an interconnection study. The customer will be responsible for the actual costs of the study. Should the actual cost of the study be less than the deposit, the difference will be refunded to the customer. Customer agrees to comply with all interconnection requirements identified in the interconnection study report.

### 6. Required Documentation

Prior to completion of the Interconnection Agreement, the following information must be provided to the Ocala Electric Utility by the customer.

- A. Documentation demonstrating that the installation complies with (or most current version at time of inspection approval):
1. IEEE 1547 (2018) Standard for Interconnecting Distributed Resources with Electric Power Systems.
  2. IEEE 1547.1 (2005) Standard Conformance Test Procedures for Equipment Interconnecting Distributed Resources with Electric Power Systems.
  3. UL 1741 (2010) Inverters, Converters, Controllers and Interconnection System Equipment for Use with Distributed Energy Resources.

(Continued on Sheet No. 19.2)

Issued by: Michael Poucher, P.E.  
 Electric Utility Director

Effective: October 1, 2019

OCALA ELECTRIC UTILITY  
OCALA, FLORIDA  
(Continued from Sheet No. 19.1)

FIRST REVISED SHEET NO. 19.2  
CANCELS ORIGINAL SHEET NO. 19.2

B. Documentation that the customer-owned renewable generation has been inspected and approved by local code officials prior to its operation in parallel with the Ocala Electric Utility system to ensure compliance with applicable local codes. OEU will also require proof of commission testing by a qualified 3<sup>rd</sup> party testing company (not affiliated in any way with the manufacturer, vendor or installation contractor), for compliance with all required and applicable codes, standards, and interconnection study requirements, prior to setting of OEU metering equipment.

C. Proof of insurance in the amount of:  
Tier 1 - \$100,000.00  
Tier 2 - \$1,000,000.00  
Tier 3 - \$2,000,000.00

**Customer**

By: Virginia Delabarrera/Michael Mccade Date: 3/30/2023  
(Print Name)

Virginia Delabarrera-McCade  
(Signature)  
Michael McCade

OCALA ELECTRIC UTILITY  
OCALA, FLORIDA

FIRST REVISED SHEET NO. 21.0  
CANCELS ORIGINAL SHEET NO. 21.0

**Tier 1 – Standard Interconnection Agreement  
Customer-Owned Renewable Generation System**

This **Agreement** is made and entered into this 30<sup>th</sup> day of March, 2023, by and between Virginia Delabarrera/Michael Mccade, (hereinafter called "**Customer**"), located at 5640 SE 2nd St in Ocala, Florida, and the City of Ocala doing business as Ocala Electric Utility (hereinafter called OEU), a body politic. Customer and OEU shall collectively be called the "**Parties**". The physical location/premise where the interconnection is taking place: 5640 SE 2nd St Ocala FL 34480.

**WITNESSETH**

**Whereas**, a Tier 1 Renewable Generation System (RGS) is an electric generating system that uses one or more of the following fuels or energy sources: hydrogen, biomass, solar energy, geothermal energy, wind energy, ocean energy, waste heat, or hydroelectric power as defined in Section 377.803, Florida Statutes, rated at no more than ten (10) kilowatts (10 kW) alternating current (AC) power output and is primarily intended to offset part or all of the Customer's current electric requirements; and

**Whereas**, OEU operates an electric system serving the City of Ocala; and

**Whereas**, Customer has made a written Application to OEU, a copy being attached hereto, to interconnect its RGS with OEU's electrical supply grid at the location identified above; and

**Whereas**, the City of Ocala and the Florida Municipal Power Agency (hereinafter called "FMPA") have entered into the All-Requirements Power Supply Contract pursuant to which the City of Ocala has agreed to purchase and receive, and FMPA has agreed to sell and supply OEU with all energy and capacity necessary to operate the OEU electric system, which limits OEU's ability to directly purchase excess energy from customer-owned renewable generation; and

**Whereas**, in order to promote the development of small customer-owned renewable generation by permitting OEU to allow its customers to interconnect with OEU's electric system and to allow OEU customers to offset their electric consumption with customer-owned renewable generation, FMPA, in accordance with the terms and conditions of this agreement, has agreed to purchase excess customer-owned generation from OEU customers interconnected to OEU's electric system; and

**Whereas**, the OEU desires to provide interconnection of a RGS under conditions which will insure the safety of OEU customers and employees, reliability and integrity of its distribution system;

**NOW, THEREFORE**, for and in consideration of the mutual covenants and agreements herein set forth, the parties hereto covenant and agree as follows:

(Continued on Sheet No. 21.1)

Issued by: Michael Poucher, P.E.  
Electric Utility Director

Effective: October 1, 2019

OCALA ELECTRIC UTILITY  
OCALA, FLORIDA  
(Continued from Sheet No. 21.0)

FIRST REVISED SHEET NO. 21.1  
CANCELS ORIGINAL SHEET NO. 21.1

1. The Customer shall be required to enter into a Tri-Party Net-Metering Purchase Power Agreement with FMPA and the City of Ocala Electric Utility (OEU).
2. "Gross power rating" (GPR) means the total manufacturer's AC nameplate generating capacity of an on-site customer-owned renewable generation system that will be interconnected to and operate in parallel with OEU's distribution facilities. For inverter-based systems, the GPR shall be calculated by multiplying the total installed DC nameplate generating capacity by 0.85 in order to account for losses during the conversion from DC to AC.
3. This agreement is strictly limited to cover a Tier 1 RGS as defined above. It is the Customer's responsibility to notify OEU of any change to the GPR of the RGS by submitting a new application for interconnection specifying the modifications at least 30 days prior to making the modifications. Increase in GPR above the ten kilowatt (10 kW) limit would necessitate entering into a new agreement at either Tier 2 or Tier 3 which may impose additional requirements on the Customer. In no case does the Tier 1, Tier 2 or Tier 3 agreement cover increases in GPR above two megawatts (2MW).
4. The RGS GPR must not exceed 90 percent (90%) of the Customer's OEU calculated distribution service rating at the Customer's location (including shared electric facilities). If the GPR does exceed the 90 percent (90%) limit, the Customer shall be responsible to pay the cost of upgrades to the distribution facilities required to accommodate the GPR capacity and ensure the 90 percent (90%) threshold is not breached. OEU will not allow a RGS GPR greater than required to offset the customer's annual kWh energy consumption (based on customer's historical consumption data or by means of estimated usage of similar type of service as determined by OEU).
5. The Customer shall not be required to pay any special fees due solely to the installation of the RGS.
6. The Customer shall fully comply with OEU's Design Standards following NEC standards as those documents may be amended or revised by OUS from time to time.
7. The Customer certifies that its installation, its operation and its maintenance shall be in compliance with the following standards (or most current version at time of inspection approval):
  - a. IEEE-1547 (2018) Standard for Interconnecting Distributed Resources with Electric Power System;
  - b. IEEE-1547.1 (2005) Standard Conformance Test Procedures for Equipment Interconnection Distributed Resources with Electric Power Systems;
  - c. UL-1741 (2010) Inverters, Converters, Controllers and Interconnection System Equipment for Use with Distributed *Energy Resources*.
  - d. The National Electric Code, state and/or local building codes, mechanical codes and/or electrical codes;
  - e. The manufacturer's installation, operation and maintenance instructions.

(Continued to Sheet No. 21.2)

Issued by: Michael Poucher, P.E.  
Electric Utility Director

Effective: October 1, 2019

OCALA ELECTRIC UTILITY  
OCALA, FLORIDA  
(Continued from Sheet No. 21.1)

FIRST REVISED SHEET NO. 21.2  
CANCELS ORIGINAL SHEET NO. 21.2

8. The Customer is not precluded from contracting for the lease, operation or maintenance of the RGS with a third party. Such lease may not provide terms or conditions that provide for any payments under the agreement to any way indicate or reflect the purchase of energy produced by the RGS. Customer shall not enter into any lease agreement that results in the retail purchase of electricity; or the retail sale of electricity from the customer-owned renewable generation. Notwithstanding this restriction, in the event that Customer is determined to have engaged in the retail purchase of electricity from a party other than OEU, then Customer shall be in breach of this Agreement and may be subject to the jurisdiction of the Florida Public Service Commission and to fines/penalties.

9. The Customer shall provide a copy of the manufacturer's installation, operation and maintenance instructions to OEU. If the RGS is leased to the Customer by a third party, or if the operation or maintenance of the RGS is to be performed by a third party, the lease and/or maintenance agreements and any pertinent documents related to these agreements shall be provided to OEU.

10. Prior to commencing parallel operation with OEU's electric system, Customer shall have the RGS inspected and approved by the appropriate code authorities having jurisdiction. Customer shall provide a copy of this inspection and approval to OEU.

11. The Customer agrees to permit OEU, if it should so choose, to inspect the RGS and its component equipment and the documents necessary to ensure compliance with this Agreement both before and after the RGS goes into service and to witness the initial testing of the RGS equipment and protective apparatus. OEU will provide Customer with as much notice as reasonably possible, either in writing, email, facsimile or by phone as to when OEU may conduct inspections and or document review. Upon reasonable notice, or at any time without notice in the event of an emergency or hazardous condition, Customer agrees to provide OEU access to the Customer's premises for any purpose in connection with the performance of the obligations required by this Agreement or, if necessary, to meet OEU's legal obligation to provide service to its customers. At least ten (10) business days prior to initially placing the customer-owned renewable generation system in service, Customer shall provide written notification to OEU advising of the date and time at which Customer intends to place the system in service, and OEU shall have the right to have personnel present on the in-service date in order to ensure compliance with the requirements of this Agreement.

(Continued on Sheet No. 21.3)

Issued by: Michael Poucher, P.E.  
Electric Utility Director

Effective: October 1, 2019

OCALA ELECTRIC UTILITY  
OCALA, FLORIDA  
(Continued from Sheet No. 21.2)

FIRST REVISED SHEET NO. 21.3  
CANCELS ORIGINAL SHEET NO. 21.3

12. The Customer's RGS must have an appropriately sized grid-tie inverter system that includes applicable protective systems. Customer certifies that the RGS equipment includes an OEU interactive inverter or interconnection system equipment that ceases to interconnect with the OEU system upon a loss of OEU's electric power. The inverter shall be considered certified for interconnected operation if it has been submitted by a manufacturer to a nationally recognized testing laboratory (NRTL) to comply with UL 1741. The NRTL shall be approved by the Occupational Safety & Health Administration (OSHA).

13. If Customer adds another RGS that (i) utilizes the same OEU interactive inverter for both systems, or (ii) utilizes a separate OEU interactive inverter for each system, Customer shall provide OEU with sixty (60) days advance written notice of the addition.

14. The Customer shall not energize the OEU system when OEU's system is deenergized. The Customer shall cease to energize the OEU system during a faulted condition on the OEU system and/or upon any notice from OEU that the deenergizing of Customer's RGS equipment is necessary. The Customer shall cease to energize the OEU system prior to automatic or non-automatic reclosing of OEU's protective devices. There shall be no intentional islanding, as described in IEEE 1547, between the Customer's and OEU' systems.

15. The Customer is responsible for the protection of its generation equipment, inverters, protection devices, and other system components from damage from the normal and abnormal operations that occur on OEU system in delivering and restoring system power. Customer agrees that any damage to any of its property, including, without limitation, all components and related accessories of its RGS system, due to the normal or abnormal operation of OEU system, is at Customer's sole risk and expense. Customer is also responsible for ensuring that the customer-owned renewable generation equipment is inspected, maintained, and tested regularly in accordance with the manufacturer's instructions to ensure that it is operating correctly and safely.

16. The Customer must install, at their expense, a manual disconnect switch of the visible load break type to provide a separation point between the AC power output of the customer-owned renewable generation system and any Customer wiring connected to OEU's system, such that back feed from the customer-owned renewable generation system to OEU's system cannot occur when the switch is in the open position. The manual disconnect switch shall be mounted separate from the meter socket on an exterior surface adjacent to the meter. The switch shall be readily accessible to OEU and capable of being locked in the open position with an OEU padlock. When locked and tagged in the open position by OEU, this switch will be under the control of OEU.

(Continued on Sheet No. 21.4)

Issued by: Michael Poucher, P.E.  
Electric Utility Director

Effective: October 1, 2019

OCALA ELECTRIC UTILITY  
OCALA, FLORIDA  
(Continued from Sheet No. 21.3)

FIRST REVISED SHEET NO. 21.4  
CANCELS ORIGINAL SHEET NO. 21.4

17. Subject to an approved inspection, including installation of acceptable disconnect switch, this Agreement shall be executed by OEU within thirty (30) calendar days of receipt of a completed application. Customer must execute this Agreement and return it to OEU at least thirty (30) calendar days prior to beginning parallel operations with OEU's electric system, subject to the requirements of Section 18, below, and within one (1) year after OEU executes this Agreement.

18. Once OEU has received Customer's written documentation that the requirements of this Agreement have been met, all agreements and documentation have been received and the correct operation of the manual switch has been demonstrated to an OEU representative, OEU will, within fifteen (15) business days, send written notice that parallel operation of the RGS may commence.

19. OEU requires the Customer to maintain general liability insurance for personal injury and property damage in the amount of not less than one hundred thousand dollars (\$100,000.00).

20. OEU will furnish, install, own and maintain metering equipment capable of measuring the flow of kilowatt-hours (kWh) of energy. The Customer's service associated with the RGS will be metered to measure the energy delivered by OEU to Customer, and measure the energy delivered by Customer to OEU. Customer agrees to provide safe and reasonable access to the premises for installation, maintenance and reading of the metering and related equipment. The Customer shall not be responsible for the cost of the installation and maintenance of the metering equipment necessary to measure the energy delivered by the Customer to OEU.

21. The Customer shall be solely responsible for all legal and financial obligations arising from the design, construction, installation, operation, maintenance and ownership of the RGS.

22. The Customer must obtain all permits, inspections and approvals required by applicable jurisdictions with respect to the generating system and must use a licensed, bonded and insured contractor to design and install the generating system. The Customer agrees to provide OEU with a copy of the local building code official inspection and certification of installation. The certification shall reflect that the local code official has inspected and certified that the installation was permitted, has been approved, and has met all electrical and mechanical qualifications.

(Continued on Sheet No. 21.5)

Issued by: Michael Poucher, P.E.  
Electric Utility Director

Effective: October 1, 2019

OCALA ELECTRIC UTILITY  
OCALA, FLORIDA  
(Continued from Sheet No. 21.4)

FIRST REVISED SHEET NO. 21.5  
CANCELS ORIGINAL SHEET NO. 21.5

23. In no event shall any statement, representation, or lack thereof, either express or implied, by OEU, relieve the Customer of exclusive responsibility for the Customer's system. Specifically, any OEU inspection of the RGS shall not be construed as confirming or endorsing the system design or its operating or maintenance procedures or as a warranty or guarantee as to the safety, reliability, or durability of the RGS. OEU's inspection, acceptance, or its failure to inspect shall not be deemed an endorsement of any RGS equipment or procedure. Further, as set forth in Sections 15 and 26 of this Agreement, Customer shall remain solely responsible for any and all losses, claims, damages and/or expenses related in any way to the operation or misoperation of its RGS equipment.

24. Notwithstanding any other provision of this Interconnection Agreement, OEU, at its sole and absolute discretion, may isolate the Customer's system from the distribution grid by whatever means necessary, without prior notice to the Customer. To the extent practical, however, prior notice shall be given. The system will be reconnected as soon as practical once the conditions causing the disconnection cease to exist. OEU shall have no obligation to compensate the Customer for any loss of energy during any and all periods when Customer's RGS is operating at reduced capacity or is disconnected from OEU's electrical distribution system pursuant to this Interconnection Agreement. Typical conditions which may require the disconnection of the Customer's system include, but are not limited to, the following:

- a. OEU system emergencies, forced outages, uncontrollable forces or compliance with prudent electric OEU practice.
- b. When necessary to investigate, inspect, construct, install, maintain, repair, replace or remove any OEU equipment, any part of OEU's electrical distribution system or Customer's generating system.
- c. Hazardous conditions existing on OEU's system due to the operation of the Customer's generation or protective equipment as determined by OEU.
- d. Adverse electrical affects (such as power quality problems) on the electrical equipment of OEU's other electric consumers caused by the Customer's generation as determined by OEU.
- e. When Customer is in breach of any of its obligations under this Interconnection Agreement or any other applicable policies and procedures of OEU.
- f. When the Customer fails to make any payments due to OEU by the due date thereof.

25. Upon termination of services pursuant to this Agreement, OEU shall open and padlock the manual disconnect switch and remove any additional metering equipment related to this Agreement. At the Customer's expense, within thirty (30) working days following the termination, the Customer shall permanently isolate the RGS and any associated equipment from OEU's electric supply system, notify OEU that the isolation is complete, and coordinate with OEU for return of OEU's lock.

(Continued to Sheet No. 21.6)

Issued by: Michael Poucher, P.E.  
Electric Utility Director

Effective: October 1, 2019

OCALA ELECTRIC UTILITY  
OCALA, FLORIDA  
(Continued from Sheet No. 21.5)

FIRST REVISED SHEET NO. 21.6  
CANCELS ORIGINAL SHEET NO. 21.6

26. To the fullest extent permitted by law, and in return for adequate, separate consideration, Customer shall indemnify, defend and hold harmless OEU, any and all of their members of its governing bodies, and its officers, agents, and employees for, from and against any and all claims, demands, suits, costs of defense, attorneys fees, witness fees of any type, losses, damages, expenses, and liabilities, whether direct, indirect or consequential, related to, arising from, or in any way connected with:

- a. Customer's design, construction, installation, inspection, maintenance, testing or operation of Customer's generating system or equipment used in connection with this Interconnection Agreement, irrespective of any fault on the part of OEU.
- b. The interconnection of Customer's generating system with, and delivery of energy from the generating system to, OEU's electrical distribution system, irrespective of any fault on the part of OEU.
- c. The performance or nonperformance of Customer's obligations under this Interconnection Agreement or the obligations of any and all of the members of Customer's governing bodies and its officers, agents, contractors (and any subcontractor or material supplier thereof) and employees.

Customer's obligations under this Section shall survive the termination of this Interconnection Agreement.

27. Customer shall not have the right to assign its benefits or obligations under this Agreement without OEU's prior written consent and such consent shall not be unreasonably withheld. If there is a change in ownership of the RGS, Customer shall provide written notice to OEU at least thirty (30) days prior to the change in ownership. The new owner will be required to assume, in writing, the Customer's rights and duties under this Agreement, or execute a new Standard Interconnection Agreement. The new owner shall not be permitted to net meter or begin parallel operations until the new owner assumes this Agreement or executes a new Agreement.

28. This Agreement supersedes all previous agreements and representations either written or verbal heretofore made between OEU and Customer with respect to matters herein contained. This Agreement, when duly executed, constitutes the only Agreement between parties hereto relative to the matters herein described. This Agreement shall continue in effect from year to year until either party gives sixty (60) days' notice of its intent to terminate this Agreement.

(Continued on Sheet No. 21.7)

Issued by: Michael Poucher, P.E.  
Electric Utility Director

Effective: October 1, 2019

OCALA ELECTRIC UTILITY  
OCALA, FLORIDA  
(Continued from Sheet No. 21.6)

FIRST REVISED SHEET NO. 21.7  
CANCELS ORIGINAL SHEET NO. 21.7

29. This Agreement shall be governed by and construed and enforced in accordance with the laws, rules and regulations of the State of Florida and OEU's tariff as it may be modified, changed, or amended from time to time, including any amendments modification or changes to OEU's Net-Metering Service Rate Schedule, the schedule applicable to this Agreement. The Customer and OEU agree that any action, suit, or proceeding arising out of or relating to this Interconnection Agreement shall be initiated and prosecuted in the state court of competent jurisdiction located in Marion County, Florida, and OEU and the Customer irrevocably submit to the jurisdiction and venue of such court. To the fullest extent permitted by law, each Party hereby irrevocably waives any and all rights to a trial by jury and covenants and agrees that it will not request a trial by jury with respect to any legal proceeding arising out of or relating to this Interconnection Agreement.

None of the provisions of this Interconnection Agreement shall be considered waived by either Party except when such waiver is given in writing. No waiver by either Party of any one or more defaults in the performance of the provisions of this Interconnection Agreement shall operate or be construed as a waiver of any other existing or future default or defaults. If any one or more of the provisions of this Interconnection Agreement or the applicability of any provision to a specific situation is held invalid or unenforceable, the provision shall be modified to the minimum extent necessary to make it or its application valid and enforceable, and the validity and enforceability of all other provisions of this Interconnection Agreement and all other applications of such provisions shall not be affected by any such invalidity or unenforceability. This Interconnection Agreement does not govern the terms and conditions for the delivery of power and energy to non-generating retail customers of OEU's electrical distribution system.

30. This Agreement incorporates by reference the terms of the tariff filed with the Florida Public Service Commission by OEU, including OEU's Net-Metering Service Rate Schedule, and associated technical terms and abbreviations, general rules and regulations and standard electric service requirements (as may be applicable) are incorporated by reference, as amended from time to time. To the extent of any conflict between this Agreement and such tariff, the tariff shall control.

31. OEU and Customer recognize that the Florida Statutes and/or the Florida Public Service Commission Rules, including those directly addressing the subject of this Agreement, may be amended from time to time. In the event that such statutes and/or rules are amended that affect the terms and conditions of this Agreement, OEU and Customer agree to supersede and replace this Agreement with a new Interconnection Agreement, which complies with the amended statutes/rules.

(Continued on Sheet No. 21.8)

Issued by: Michael Poucher, P.E.  
Electric Utility Director

Effective: October 1, 2019

OCALA ELECTRIC UTILITY  
OCALA, FLORIDA  
(Continued from Sheet No. 21.7)

FIRST REVISED SHEET NO. 21.8  
CANCELS ORIGINAL SHEET NO. 21.8

32. Customer acknowledges that its provision of electricity to OEU hereunder is on a first-offered, first-accepted basis and subject to diminution and/or rejection in the event the total amount of electricity delivered to OEU pursuant to the OEU's Net-Metering Service Rate Schedule, (as filed with the Florida Public Service Commission), from all participating OEU customers, exceeds two and one-half percent (2.5%) of the aggregate customer peak demand on the OEU system.

33. This Agreement is solely for the benefit of OEU and Customer and no right nor any cause of action shall accrue upon or by reason, to or for the benefit of any third party not a formal party to this Agreement. Nothing in this Agreement, expressed or implied, is intended or shall be construed to confer upon any person or corporation other than OEU or Customer, any right, remedy, or claim under or by reason of this Agreement or any of the provisions or conditions of this Agreement; and, all provisions, representations, covenants, and conditions contained in this Agreement shall inure to the sole benefit of and be binding upon OEU and Customer and their respective representatives, successors, and assigns. Further, no term or condition contained in this Agreement shall be construed in any way as a waiver by OEU of the sovereign immunity applicable to OEU as established by Florida Statutes, 768.28.

(Continued on Sheet No. 21.9)

Issued by: Michael Poucher, P.E.  
Electric Utility Director

Effective: October 1, 2019

OCALA ELECTRIC UTILITY  
OCALA, FLORIDA  
(Continued from Sheet No. 21.8)

FIRST REVISED SHEET NO. 21.9  
CANCELS ORIGINAL SHEET NO. 21.9

IN WITNESS WHEREOF, Customer and OEU have executed this Agreement the day and year first above written.

**City of Ocala Electric Utility:**

By: DocuSigned by:  
Janice Mitchell  
55198B43858A4E1...  
Title: CFO  
Date: 4/21/2023

**Customer:**

By: Virginia Delabarrera/Michael Mccade  
(Print Name)  
Virginia Delabarrera Mccade / Michael  
(Signature) Mccade  
Date: 03/30/2023

City of Ocala Electric Utility Account Number:  
530802-138937

**Approved as to form and legality:**

DocuSigned by:  
William E. Sexton  
807DCFC4E88E429...  
**William E. Sexton**  
City Attorney

OCALA ELECTRIC UTILITY  
OCALA, FLORIDA

FIRST REVISED SHEET NO. 20.0  
CANCELS ORIGINAL SHEET NO. 20.0

### **Tri-Party Net-Metering Power Purchase Agreement**

This Tri-Party Net-Metering Power Purchase Agreement (this "Agreement") is entered into this 30th day of March, 20 23, by and between the Florida Municipal Power Agency, a governmental joint action agency created and existing under the laws of the State of Florida (hereinafter "FMPA"), the City of Ocala doing business as Ocala Electric Utility, a body politic (hereinafter "OEU"), and Virginia Delabarerra / Michael Mccade, a retail electric customer of OEU (hereinafter "Customer").

#### **Section 1. Recitals**

1.01. OEU and Customer have executed OEU's Standard Interconnection Agreement for a Customer-Owned Renewable Generation System (RGS) pursuant to which OEU has agreed to permit interconnection of Customer's renewable generation to OEU's electric system at Customer's presently-metered location, and Customer has agreed to deliver excess electric energy generated by Customer's Renewable Generation System to OEU's electric distribution system;

1.02. The City of Ocala and FMPA have entered into the All-Requirements Power Supply Contract, dated as of May 1, 1986, (hereinafter the "ARP Contract") pursuant to which the City of Ocala has agreed to purchase and receive, and FMPA has agreed to sell and supply OEU with all energy and capacity necessary to operate the OEU electric system, which limits OEU's ability to directly purchase excess energy from customer-owned renewable generation.

1.03. In order to promote the development of small customer-owned renewable generation by permitting OEU to allow its customers to interconnect with OEU's electric system and to allow OEU's electric customers to offset their electric consumption with customer-owned renewable generation, FMPA, in accordance with the terms and conditions of this agreement, has agreed to purchase excess customer-owned generation from OEU's electric customers interconnected to OEU's electric system.

NOW THEREFORE, for and in consideration of the mutual covenants and agreements set forth herein, the Parties covenant and agree as follows:

#### **Section 2. Interconnection**

2.01. Customer shall not begin parallel operations with the OEU electric distribution system until Customer has executed OEU's electric Standard Interconnection Agreement for Small Customer-Owned Renewable Generation and is in compliance with all terms and conditions

OEU requires that the customer install and operate the RGS in accordance with all applicable safety codes and standards. OEU shall establish and enforce terms and conditions of operation and disconnection of all interconnected customer-owned renewable generation as it relates to the effect of the RGS on OEU's electric distribution system.

(Continued on Sheet No. 20.1)

Issued by: Michael Poucher, P.E.  
Electric Utility Director

Effective: October 1, 2019

Ocala Electric Utility  
Ocala, Florida  
(Continued from Sheet No. 20.0)

FIRST REVISED SHEET NO. 20.1  
CANCELS ORIGINAL SHEET NO. 20.1

### **Section 3. Metering**

3.01 In accordance with the OEU's Standard Interconnection Agreement for Customer-Owned Renewable Generation, OEU shall install metering equipment at the point of delivery capable of recording two separate kWh meter readings: (1) the flow of electricity from OEU to the Customer (Delivered), and (2) the flow of excess electricity from the Customer to OEU. OEU shall take meter readings on the same cycle as the otherwise applicable rate schedule.

### **Section 4. Purchase of Excess Customer-Owned Renewable Generation**

4.01. Customer-owned renewable generation shall be first used for Customer's own load and shall offset Customer's demand for OEU's electricity. All electric power and energy delivered by OEU to Customer shall be received and paid for by Customer to OEU (Received) pursuant to the terms, conditions and rates of the OEU otherwise applicable rate schedule.

4.02. Excess customer-owned renewable generation shall be delivered to the OEU Electric distribution system. For purposes of this Agreement, the term "excess customer-owned renewable generation" means any kWh of electrical energy produced by the customer-owned renewable generation system that is not consumed by Customer and is delivered to the OEU electric distribution system. FMPA agrees to purchase and receive, and Customer agrees to sell and deliver, all excess customer-owned renewable generation at the energy rate established by FMPA, which shall be calculated in accordance with Schedule A. Excess customer-owned renewable generation shall be purchased in the form of a credit on Customer's monthly energy consumption bill from OEU.

4.03. In the event that a given monthly credit for excess customer-owned renewable generation exceeds the total billed amount for Customer's consumption in any corresponding month, then the excess credit shall be applied to the subsequent month's bill. Excess energy credits produced pursuant to the preceding sentence shall accumulate and be used to offset Customer's energy consumption bill for a period of not more than twelve (12) months. At the end of each calendar year, any unused excess energy credits shall be paid by OEU to the Customer in accordance with the OEU Electric Net-Metering Service Rate Schedule.

(Continued on Sheet No. 20.2)

Issued by: Michael Poucher, P.E.  
Electric Utility Director

Effective: October 1, 2019

OCALA ELECTRIC UTILITY  
OCALA, FLORIDA  
(Continued from Sheet No. 20.1)

FIRST REVISED SHEET NO. 20.2  
CANCELS ORIGINAL SHEET NO. 20.2

4.04. FMPA and OEU shall not be required to purchase or receive excess customer-owned renewable generation, and may require Customer to interrupt or reduce production of customer-owned renewable generation, (a) when necessary in order to construct, install, maintain, repair, replace, remove, investigate, or inspect any OEU equipment or part of OEU's system; or (b) if either FMPA or OEU determine, in their sole judgment, that curtailment, interruption, or reduction is necessary because of emergencies, forced outages, force majeure, or compliance with any applicable electric code or standard.

4.05. Customer acknowledges that its provision of electricity to OEU hereunder is on a first-offered, first-accepted basis and subject to diminution and/or rejection in the event the total amount of electricity delivered to OEU pursuant to the Net-Metering Service Rate Schedule (as filed with the Florida Public Service Commission), from all participating OEU customers, exceeds two and one-half percent (2.5%) of the aggregate customer peak demand on the OEU electric system.

#### **Section 5. Renewable Energy Credits**

5.01. Customer shall offer FMPA a first right of refusal before selling or granting to any third party the right to the Green Attributes associated with its customer-owned renewable generation that is interconnected to OEU electric distribution system. The term "Green Attributes" shall include any and all credits, certificates, benefits, environmental attributes, emissions reductions, offsets, and allowances, however entitled, attributable to the generation of electricity from the customer-owned-renewable generation and its displacement of conventional energy generation.

5.02. Any additional meter(s) installed to measure total renewable electricity generated by the Customer for the purposes of measuring Green Attributes, including and renewable energy certificates (or similarly titled credits for renewable energy generated), shall be installed at the expense of the Customer, unless determined otherwise during negotiations for the sale of the Customer's credits to FMPA.

#### **Section 6. Term and Termination**

6.01. This Agreement shall become effective upon execution by all Parties, and shall remain in effect thereafter on a month-to-month basis until terminated by any Party upon thirty (30) days written notice to all other Parties.

6.02. This Agreement shall terminate immediately and without notice upon: (a) termination of the electric distribution service by OEU or (b) failure by Customer to comply with any of the terms and conditions of this Agreement or OEU's Standard Interconnection Agreement for Customer-Owned Renewable Generation.

(Continued on Sheet No. 20.3)

Issued by: Michael Poucher, P.E.  
Electric Utility Director

Effective: October 1, 2019

OCALA ELECTRIC UTILITY  
OCALA, FLORIDA  
(Continued from Sheet No. 20.2)

FIRST REVISED SHEET NO. 20.3  
CANCELS ORIGINAL SHEET NO. 20.3

### **Section 7. Miscellaneous Provisions**

7.01. Assignment. It is understood and agreed that no party may transfer, sell, mortgage, pledge, hypothecate, convey, designate, or otherwise assign this Agreement, or any interest herein or any rights or obligations hereunder, in whole or in part, either voluntarily or by operation of law, (including, without limitation, by merger, consolidation, or otherwise), without the express written consent of the other parties (and any such attempt shall be void), which consent shall not be unreasonably withheld. Subject to the foregoing, this Agreement shall inure to the benefit of and be binding upon the parties and their respective successors and permitted assigns.

7.02. Amendment. It is understood and agreed that FMPA and OEU reserve the right, on no less than an annual basis, to change any of the terms and conditions, including pricing, in this Agreement on sixty (60) days advance written notice. FMPA and OEU may make such changes on an immediate basis in the event any applicable law, rule, regulation or court order requires them. In such event, FMPA and OEU will give Customer as much notice as reasonably possible under the circumstances.

7.03. Indemnification. To the fullest extent permitted by laws and regulations, and in return for adequate, separate consideration, Customer shall defend, indemnify, and hold harmless FMPA and OEU, their officers, directors, agents, guests, invitees, and employees from and against all claims, damages, losses to persons or property, whether direct, indirect, or consequential (including but not limited to fees and charges of attorneys, and other professionals and court and arbitration costs) arising out of, resulting from, occasioned by, or otherwise caused by the operation or misoperation of the customer-owned renewable generation, or the acts or omissions of any other person or organization directly or indirectly employed by the Customer to install, furnish, repair, replace or maintain the customer-owned renewable generation system, or anyone for whose acts any of them may be liable.

7.04. Governing Law. The validity and interpretation of this Agreement and the rights and obligations of the parties shall be governed and construed in accordance with the laws of the State of Florida without regard for any conflicts of law provisions that might cause the law of other jurisdictions to apply. All controversies, claims, or disputes arising out of or related to this Agreement or any agreement, instrument, or document contemplated hereby, shall be brought exclusively in the County or Circuit Court for Marion County, Florida, or the United States District Court sitting in Marion County, Florida, as appropriate.

(Continued on Sheet No. 20.4)

Issued by: Michael Poucher, P.E.  
Electric Utility Director

Effective: October 1, 2019

OCALA ELECTRIC UTILITY  
OCALA, FLORIDA  
(Continued from Sheet No. 20.3)

FIRST REVISED SHEET NO. 20.4  
CANCELS ORIGINAL SHEET NO. 20.4

7.05. Enforcement of Agreement. In the event that either party is required to enforce this Agreement by court proceedings or otherwise, the prevailing party shall be entitled to recover all fees and costs incurred, including reasonable attorney's fees and costs for trial, alternative dispute resolution, and/or appellate proceedings.

7.06. Severability. To the extent any provision of this Agreement is prohibited by or invalid under applicable law, such provision shall be ineffective to the extent of such prohibition or invalidity, without invalidating the remainder of such provision or the remaining provisions of this Agreement.

7.07. Third Party Beneficiaries and Sovereign Immunity. This Agreement is solely for the benefit of FMPA, OEU, and Customer and no right nor shall any cause of action accrue upon or by reason, to or for the benefit of any third party not a formal party to this Agreement. Nothing in this Agreement, expressed or implied, is intended or shall be construed to confer upon any person or corporation other than FMPA, OEU, or Customer, any right, remedy, or claim under or by reason of this Agreement or any of the provisions or conditions of this Agreement; and, all provisions, representations, covenants, and conditions contained in this Agreement shall inure to the sole benefit of and be binding upon FMPA, OEU, and Customer and their respective representatives, successors, and assigns. Further, no term or condition contained in this Agreement shall be construed in any way as a waiver by either FMPA or OEU of the sovereign immunity applicable to either or both of them as established by Florida Statutes, 768.28.

(Continued on Sheet No. 20.5)

Issued by: Michael Poucher, P.E.  
Electric Utility Director

Effective: October 1, 2019

OCALA ELECTRIC UTILITY  
OCALA, FLORIDA  
(Continued from Sheet No. 20.4)

FIRST REVISED SHEET NO. 20.5  
CANCELS ORIGINAL SHEET NO. 20.5

IN WITNESS WHEREOF, Customer and OEU have executed this Agreement the day and year first above written.

**City of Ocala Electric Utility**

By: DocuSigned by:  
Janice Mitchell  
6510B843B8A4E1...  
Title: CFO  
Date: 4/21/2023

**Florida Municipal Power Agency**

By: DocuSigned by:  
  
0K7F9REB5348474...  
Title: VP of IT/OT and System Ops  
Date: 4/21/2023

**Customer**

By: Virginia Delabarrera/Michael Mccade Date: \_\_\_\_\_  
(Print Name)

  
(Signature)

Customer's City of Ocala Electric Utility Account Number: 530802-138937

Approved as to form and legality:

DocuSigned by:  
William E. Sexton  
807DCFC1E88E429...  
William E. Sexton  
City Attorney

(Continued on Sheet No. 20.6)

Issued by: Michael Poucher, P.E.  
Electric Utility Director

Effective: October 1, 2019

Ocala Electric Utility  
Ocala, Florida  
(Continued from Sheet No. 20.5)

FIRST REVISED SHEET NO. 20.6  
CANCELS ORIGINAL SHEET NO. 20.6

**Tri-Party Net-Metering Power Purchase Agreement  
Schedule A**

**I. All-Requirements Project Calculation of Excess Customer-Owned Renewable Generation Credit**

- a) FMPA shall pay OEU for the excess kWh energy delivered by customer-owned renewable generation to OEU's electric system. Every month, OEU shall determine the total kWh of customer-owned renewable generation that is delivered to OEU's electric system, and shall send the information to FMPA as soon as it becomes available, but no later than the second working day of every month. FMPA will then provide a monthly payment to OEU in the form of a credit on the ARP power bill for the excess energy delivered to the distribution grid. The ARP Renewable Generation Credit will be calculated as follows:

**ARP Renewable Generation Credit = Quarterly Energy Rate \* Monthly kWh of excess customer-owned renewable generation**

**Quarterly Energy Rate = 3 month average of ARP energy rate. FMPA will update the Quarterly Energy Rate every April 1, July 1, October 1 and January 1.**

- b) As part of the monthly bill adjustment, FMPA will also increase OEU's kWh billing amount by the same kWh amount as the customer-owned renewable generation purchased by FMPA. This adjustment is necessary because excess customer generation that flows onto OEU's electric system has been purchased by FMPA, but will remain on OEU's electric system and be used by OEU to meet its other customers' electric needs. As a result, OEU's monthly ARP bill will be adjusted accordingly to reflect FMPA's subsequent sale of this energy to OEU.

**II. Payment for Unused Excess Energy Credits**

- a) Monthly excess energy credits shall accumulate and be used to offset the Customer's following month energy consumption bill for a period of not more than twelve (12) months.
- b) At the end of each calendar year, OEU shall pay the Customer for any unused excess energy credits in accordance with the OEU Electric Net-Metering Service Rate Schedule.



## IQ8 and IQ8+ Microinverters

Our newest IQ8 Microinverters are the industry's first microgrid-forming, software-defined microinverters with split-phase power conversion capability to convert DC power to AC power efficiently. The brain of the semiconductor-based microinverter is our proprietary application-specific integrated circuit (ASIC) which enables the microinverter to operate in grid-tied or off-grid modes. This chip is built in advanced 55nm technology with high speed digital logic and has super-fast response times to changing loads and grid events, alleviating constraints on battery sizing for home energy systems.

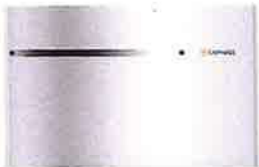

Part of the Enphase Energy System, IQ8 Series Microinverters integrate with the Enphase IQ Battery, Enphase IQ Gateway, and the Enphase App monitoring and analysis software.



IQ8 Series Microinverters redefine reliability standards with more than one million cumulative hours of power-on testing, enabling an industry-leading limited warranty of up to 25 years.



Connect PV modules quickly and easily to IQ8 Series Microinverters using the included Q-DCC-2 adapter cable with plug-n-play MC4 connectors.



IQ8 Series Microinverters are UL Listed as PV Rapid Shut Down Equipment and conform with various regulations, when installed according to manufacturer's instructions.

### Easy to install

- Lightweight and compact with plug-n-play connectors
- Power Line Communication (PLC) between components
- Faster installation with simple two-wire cabling

### High productivity and reliability

- Produce power even when the grid is down
- More than one million cumulative hours of testing
- Class II double-insulated enclosure
- Optimized for the latest high-powered PV modules

### Microgrid-forming

- Complies with the latest advanced grid support
- Remote automatic updates for the latest grid requirements
- Configurable to support a wide range of grid profiles
- Meets CA Rule 21 (UL 1741-SA) requirements

# IQ8 and IQ8+ Microinverters

INPUT DATA (DC)		I08-60-2-US	I08PLUS-72-2-US
Commonly used module pairings <sup>1</sup>	W	235 – 350	235 – 440
Module compatibility		60-cell/120 half-cell	60-cell/120 half-cell and 72-cell/144 half-cell
MPPT voltage range	V	27 – 37	29 – 45
Operating range	V	25 – 48	25 – 58
Min/max start voltage	V	30 / 48	30 / 58
Max input DC voltage	V	50	60
Max DC current <sup>2</sup> [module Isc]	A		15
Overvoltage class DC port			II
DC port backfeed current	mA		0
PV array configuration		1x1 Ungrounded array; No additional DC side protection required; AC side protection requires max 20A per branch circuit	
OUTPUT DATA (AC)		I08-60-2-US	I08PLUS-72-2-US
Peak output power	VA	245	300
Max continuous output power	VA	240	290
Nominal (L-L) voltage/range <sup>3</sup>	V	240 / 211 – 264	
Max continuous output current	A	1.0	1.21
Nominal frequency	Hz	60	
Extended frequency range	Hz	50 – 68	
Max units per 20 A (L-L) branch circuit <sup>4</sup>		16	13
Total harmonic distortion		<5%	
Overvoltage class AC port		III	
AC port backfeed current	mA	30	
Power factor setting		1.0	
Grid-tied power factor (adjustable)		0.85 leading – 0.85 lagging	
Peak efficiency	%	97.5	97.6
CEC weighted efficiency	%	97	97
Night-time power consumption	mW	60	
MECHANICAL DATA			
Ambient temperature range		-40°C to +60°C (-40°F to +140°F)	
Relative humidity range		4% to 100% (condensing)	
DC Connector type		MC4	
Dimensions (HxWxD)		212 mm (8.3") x 175 mm (6.9") x 30.2 mm (1.2")	
Weight		1.08 kg (2.38 lbs)	
Cooling		Natural convection – no fans	
Approved for wet locations		Yes	
Acoustic noise at 1 m		<60 dBA	
Pollution degree		PD3	
Enclosure		Class II double-insulated, corrosion resistant polymeric enclosure	
Environ. category / UV exposure rating		NEMA Type 6 / outdoor	
COMPLIANCE			
Certifications		CA Rule 21 (UL 1741-SA), UL 62109-1, UL1741/IEEE1547, FCC Part 15 Class B, ICES-0003 Class B, CAN/CSA-C22.2 NO. 107.1-01	
		This product is UL Listed as PV Rapid Shut Down Equipment and conforms with NEC 2014, NEC 2017, and NEC 2020 section 690.12 and C22.1-2018 Rule 64-218 Rapid Shutdown of PV Systems, for AC and DC conductors, when installed according to manufacturer's instructions.	

(1) No enforced DC/AC ratio. See the compatibility calculator at <https://link.enphase.com/module-compatibility> (2) Maximum continuous input DC current is 10.6A (3) Nominal voltage range can be extended beyond nominal if required by the utility. (4) Limits may vary. Refer to local requirements to define the number of microinverters per branch in your area.

American Strategic Insurance Corp  
 1 ASI Way  
 St. Petersburg, FL 33702  
 Phone: (727) 374-2502



**Premises Only Liability Declarations Page**

**Agent:**  
 Professional Property & Casualty, LLC  
 2050 Winter Springs Blvd  
 Oviedo, FL 32765  
  
**Agent Code:** 418438  
**For Policy Service, Call:** (407) 366-7746

**Total Policy Premium:** \$210  
**Policy Number:** FLU149203  
**Plan Type:** UMB

**Policy Period:** From: 09/10/2022 To: 09/10/2023

**Effective Date of Transaction:** 09/10/2022  
**Transaction Type:** New Business

**Named Insured:**  
 MICHAEL MCCABE VIRGINIA DELABARRERA  
 5640 SE 2ND ST  
 OCALA, FL 34480

**Premises Location(s):**  
 5640 SE 2ND ST , OCALA, FL 34480-3563

**Coverage Limit:** \$ 1,000,000

<b>Coverages</b>	<b>Limit</b>	<b>Premium</b>
Liability Base Premium	\$ 1,000,000	\$200.00
<b>Surcharges &amp; Discounts</b>		
Desired Coverage Limit		\$0.00
Increased Underlying Property Liability		\$0.00
Territory Factor (UIM)		\$0.00
Premises Only Credit		(\$59.00)
Swimming Pool/Spas		\$40.00
Minimum Limit Premium Adjustment		\$0.00
Managing General Agent Fee		\$25.00
Florida Insurance Guaranty Association Fee		\$3.62
<b>TOTAL POLICY PREMIUM:</b>		<b>\$210.00</b>

**All Insureds:**

McCabe, Michael

**Policy Forms:**

Amendment of Policy Provisions - Florida	ASI PUP FL SP 10 20
Premises Liability	ASI PUP 005 09 99
Auto Liability Exclusion - Florida	ASI PUP FL ALE 10 20
Public Or Livery Conveyance Exclusion - Florida	ASI PUP FL PCE 10 20
Personal Umbrella Liability Policy	DL 98 01 06 98

**Additional Interest:**

President

Agent

Policyholder: MICHAEL MCCABE VIRGINIA DELABARRERA

Policy ID: FLU149203

**Required Retained Limits**

**All Automobiles, Motorcycles, Motorhomes, Mopeds, and All Road Licensed Vehicles:**

**Required Retained Limits** (Does not apply for Premises Only Liability policies)

\$250,000 / \$500,000 / \$100,000 or \$300,000 CSL for policies with any drivers age 22-79

\$500,000 / \$500,000 / \$500,000 or \$500,000 CSL for policies with any drivers 21 and younger or 80 and older \*

**All Automobiles and Motorhomes Requesting UM Coverage:**

**Required Retained Limits**

UM: \$250,000 / \$500,000 / \$100,000 or \$300,000 CSL for policies with any drivers age 22-79

UM: \$500,000 / \$500,000 / \$500,000 or \$500,000 CSL for policies with any drivers 21 and younger or 80 and older

**Comprehensive Personal Liability, Homeowners, or Farm Comprehensive Personal Liability:**

**Required Retained Limits**

\$300,000

**Residential Rental Properties Covered Under the Dwelling Fire Policy for 1-4 Family Residences:**

**Required Retained Limits**

\$300,000

**Personal Injury Coverage Endorsed to the Homeowners Policy (whenever available):**

**Required Retained Limits** (Does not apply for Premises Only Liability policies)

\$300,000

**All Recreational Vehicles Including Golf Carts, Utility Vehicles, Trail Bikes or Other Vehicles Not Required to be Licensed:**

**Required Retained Limits** (Does not apply for Premises Only Liability policies)

\$250,000 / \$500,000 / \$100,000 or \$300,000 CSL

**Watercraft:**

**Required Retained Limits** (Does not apply for Premises Only Liability policies)

\$250,000 / \$500,000 / \$100,000 or \$300,000 CSL

\* Required Retained Limits are reduced to \$250,000/\$500,000/\$100,000 or \$300,000 CSL when the Underlying Automobile Surcharge is applied.

**Detailed Schedule**

**Automobiles**

<u>Make</u>	<u>Model</u>
N/A	N/A

**Motorcycles and Mopeds**

<u>Make</u>	<u>Model</u>
N/A	N/A

**Watercraft**

<u>Make</u>	<u>Model</u>	<u>Length (ft)</u>	<u>MPH</u>
N/A	N/A	N/A	N/A

**Golf Carts, Utility Vehicles or Recreational Vehicles**

<u>Make</u>	<u>Model</u>
N/A	N/A

**Motorhomes**

<u>Make</u>	<u>Model</u>
N/A	N/A



**SCOPE OF WORK:**  
 TO INSTALL A ROOF MOUNTED SOLAR PHOTOVOLTAIC SYSTEM AT THE OWNER RESIDENCE LOCATED AT 5640 SE 2ND ST, OCALA, FL 34480.

SYSTEM DC RATING: 11,60 KWDC  
 SYSTEM AC RATING: 8.42 KWAC

**GENERAL NOTES:**

- THESE CONSTRUCTION DOCUMENTS HAVE BEEN BASED ON FIELD INSPECTIONS AND OTHER INFORMATION AVAILABLE AT THE TIME. ACTUAL FIELD CONDITIONS MAY REQUIRE MODIFICATIONS IN CONSTRUCTION DETAIL.
- CONTRACTOR HAS THE FULL RESPONSIBILITY TO CHECK AND VERIFY ALL DIMENSIONS AND EXISTING CONDITIONS. ANY DISCREPANCIES SHALL BE REPORTED TO THE ENGINEER BEFORE PROCEEDING WITH THE WORK. ANY WORK STARTED BEFORE CONSULTATION AND ACCEPTANCE BY THE ENGINEER SHALL BE THE SOLE RESPONSIBILITY OF THE CONTRACTOR AND SHALL BE SUBJECT TO CORRECTION BY THEM WITHOUT ADDITIONAL COMPENSATION.
- THE CONTRACTOR SHALL BE HELD RESPONSIBLE FOR THE PROPER INSTALLATION AND COMPLETION OF THE WORK WITH APPROVED MATERIALS.
- THE EQUIPMENT AND ALL ASSOCIATED WIRING AND INTERCONNECTION SHALL BE INSTALLED ONLY BY QUALIFIED PEOPLE. A QUALIFIED PERSON IS ONE WHO HAS SKILLS AND KNOWLEDGE RELATED TO THE CONSTRUCTION AND OPERATION OF THE ELECTRICAL EQUIPMENT AND INSTALLATIONS AND HAS RECEIVED SAFETY TRAINING TO RECOGNIZE AND AVOID THE HAZARDS INVOLVED. (NEC 680.4(C), NEC 2017).
- NEW CONDUIT ROUTING SHOWN IS ESSENTIALLY SCHEMATIC. CONTRACTOR SHALL LAY OUT RUNS TO SUIT FIELD CONDITIONS AND THE COORDINATION REQUIREMENTS OF OTHER TRADES.
- ARRAY WIRING SHOULD NOT BE READILY ACCESSIBLE EXCEPT TO QUALIFIED PERSONNEL.
- THE AC DISCONNECT MUST BE ACCESSIBLE TO QUALIFIED UTILITY PERSONNEL, BE LOCKABLE, AND BE A VISIBLE-BREAK SWITCH.

**SHEET INDEX**

CS-0	COVER SHEET & BOM
E-1	STRING LAYOUT & SIGNAGE
E-2	ELECTRICAL DIAGRAM & CALCS.
E-3	EQUIPMENT SPECIFICATIONS

**GOVERNING CODES**

2018 NFPA 1 (FIRE CODE)  
 2017 NATIONAL ELECTRICAL CODE  
 2020 FLORIDA BUILDING CODE (7TH EDITION)

AUTHORITY: HAVASUBURDICTION (HAWAII), KANSAS COUNTY

**BILL OF MATERIALS**

EQUIPMENT	QTY	DESCRIPTION
SOLAR PV MODULE	29	Q-PEAK DUO BLK ML-G10+ 400W
MICROINVERTER	29	ENPHASE (ORPLUS 72-2-US
JUNCTION BOX	1	JUNCTION BOX, NEMA 3R, UL LISTED
COMBINER BOX	1	ENPHASE IQ COMBINER 40C W/ IQ ENVOY (K-IQ-AMI-240-4)
AC DISCONNECT	1	FUSED AC DISCONNECT, 240V, NEMA 3R, UL LISTED
POWER PERFECT BOX	1	FE-1PN, 120V/240V, NEMA 3X



ATLANTIC KEY ENERGY LLC  
 7809 STAPPOINT CT  
 STE B  
 WINTER PARK, FL 32782  
 +1 (877) 888-0273

PROJECT NAME & ADDRESS

VIRGINIA MCCABE  
 RESIDENCE  
 5640 SE 2ND ST  
 OCALA, FL 34480

**ENGINEER CONTACT INFORMATION**

SCOTT WASSING  
 LICENSE #81859  
 78 N WOODBROOK DR,  
 ALPINE, UT 84004

SIGNATURE WITH SEAL

**REVISIONS**

DESCRIPTION	DATE	REV
SYSTEM CHANGE	03/06/20	A

Drawn By: \_\_\_\_\_  
 Checked By: \_\_\_\_\_  
 Date: \_\_\_\_\_

SHEET NAME

COVER SHEET & BOM

SHEET NUMBER

CS-0

THIS ITEM HAS BEEN DIGITALLY SIGNED AND SEALED BY SCOTT WASSING ON THE DATE ADJACENT TO THE SEAL. PRINTED COPIES OF THIS DOCUMENT ARE NOT VALID. ANY CHANGES TO THIS DOCUMENT MUST BE MADE ON ANY ELECTRONIC COPIES.





ATLANTIC KEY ENERGY LLC  
7088 STAPPOINT CT  
WINTER PARK, FL 32782  
P: (907) 984-0273  
PROJECT NAME & ADDRESS

VIRGINIA MCCABE  
RESIDENCE  
5640 SE 2ND ST  
OCALA, FL 34480

ENGINEER CONTACT INFORMATION  
SCOTT WYSSING  
LICENSER 19058  
10000 DR.  
ALPHARETTA, VA 24504  
SIGNATURE WITH SEAL

REVISIONS	DATE	REV
DESCRIPTION	DATE	REV
SYSTEM CHANGE	08/08/18	A

Drawn By: D.S.  
Checked By: S.M.  
Date: 8/8/18  
SHEET NAME: E-2  
ELECTRICAL LINE DIAGRAM & CALCS.  
SHEET NUMBER

ID	INITIAL CONDUCTOR LOCATION	FINAL CONDUCTOR LOCATION	MIN CONDUCTOR SIZE (AWG)	MIN DIA CONDUCTOR SIZE (IN.)	# OF PARALLEL CIRCUITS	CURRENT-CARRYING CONDUCTORS IN CONDUIT	OCPD (A)	MIN EGC SIZE (AWG)	TEMP CORR FACTOR	CONDUIT FILL FACTOR	CONT. CURRENT (A)	MAX CURRENT (A)	BASE AMP. (A)	DERATED AMP. (A)	TERM AMP. RATING (A)	LENGTH (FT)	VOLTAGE DROP (%)
1	STRING A	JUNCTION BOX	1/2" Q CABLE	N/A	1	2	N/A	6	0.75	N/A	13.31	16.64	30	N/A	N/A	42.00	0.82
2	STRING B	JUNCTION BOX	1/2" Q CABLE	N/A	1	2	N/A	6	0.75	N/A	12.1	15.13	30	N/A	N/A	43.00	0.86
3	STRING C	JUNCTION BOX	1/2" Q CABLE	N/A	1	2	N/A	6	0.75	N/A	9.88	12.10	30	N/A	N/A	43.00	0.87
4	JUNCTION BOX	IG COMBINER	10 THWN-2 COPPER	0.75 LTM	1	2	20	10	0.75	1	13.31	16.64	40	30.4	35	35.00	0.48
5	IG COMBINER	AC DISCONNECT	8 THWN-2 COPPER	0.75 LTM	1	3	50	10	0.86	1	35.08	43.86	55	52.8	50	5.00	0.11
7	AC DISCONNECT	MSP	8 THWN-2 COPPER	0.75 LTM	1	3	N/A	-	0.86	1	35.08	43.86	75	72.0	85	5.00	0.07

NOTE: LTM OR EQUIVALENT TYPE CONDUIT

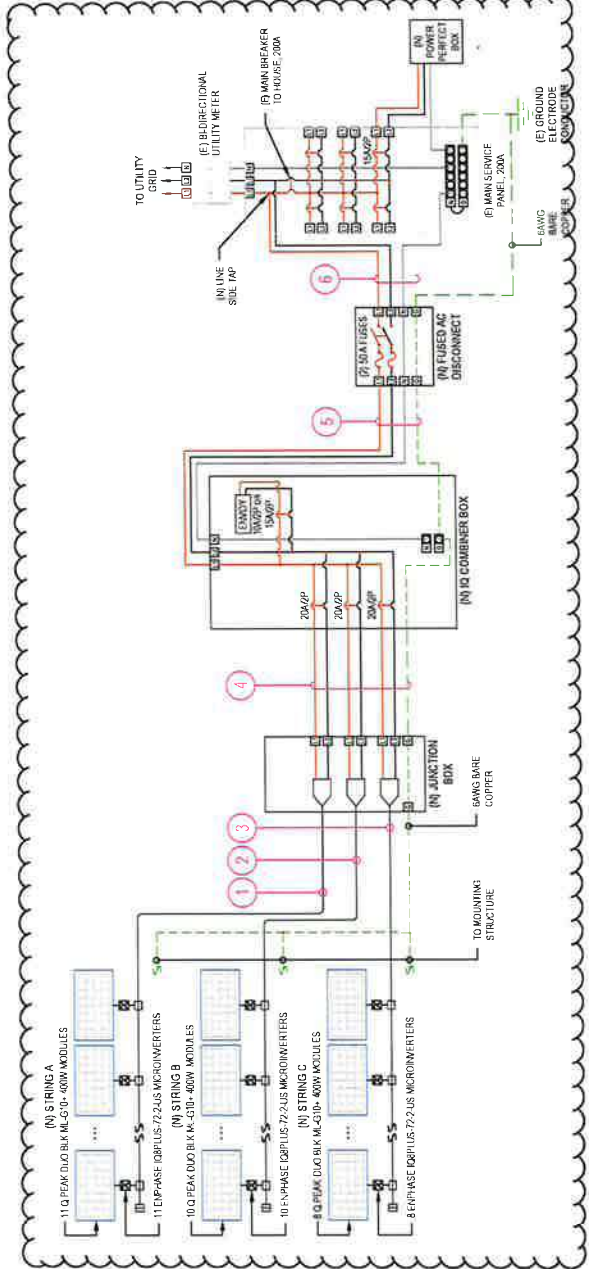

LEGEND  
 (E) - PASTING  
 (N) - NEW

DESIGN TEMPERATURE SPECIFICATIONS  
 RECORD LOW TEMP: 6°C  
 AMBIENT TEMP (HIGH TEMP 2%): 34°C  
 CONDUIT HEIGHT: 1.0'  
 CONDUCTOR TEMPERATURE RATE (ROOF): 55°C

INSULATION PIERCING CONNECTORS WILL BE USED FOR LINELOAD WIRE CONNECTION

1 ELECTRICAL LINE DIAGRAM  
 SCALE: NIS  
 E-2

THIS ITEM HAS BEEN DIGITALLY SIGNED AND SEALED BY SCOTT WYSSING ON THE DATE ADJACENT TO THE SEAL. PRINTED COPIES OF THIS DOCUMENT ARE NOT CONSIDERED SIGNED AND SEALED AND THE SIGNATURE MUST BE VERIFIED USING ELECTRONIC COPIES.









Scott E. Wyssling, PE  
Jon P. Ward, SE, PE  
Gregory T. Elvestad, PE

76 North Meadowbrook Drive  
Alpine, UT 84004  
office (201) 874-3483  
swyssling@wysslingconsulting.com

August 5, 2022

Scott  
Wyssling,  
PE

Digitally signed by Scott Wyssling, PE  
DN: C=US, S=Utah, L=Alpine,  
O=Wyssling Consulting, CN="Scott  
Wyssling, PE",  
E=swyssling@wysslingconsulting.com  
Reason: I am the author of this  
document  
Location: your signing location here  
Date: 2022.08.05 12:18:45-06'00'  
Foxit PDF Editor Version: 11.1.0

Lumio Solar  
12600 Challenger Parkway, Suite 200  
Orlando, FL 32826

Re: Engineering Services  
McCabe Residence  
5640 Southeast 2<sup>nd</sup> Street, Ocala FL  
16.800 kW System

To Whom It May Concern:

We have received information regarding solar panel installation on the roof of the above referenced structure. Our evaluation of the structure is to verify the existing capacity of the roof system and its ability to support the additional loads imposed by the proposed solar system.

**A. Site Assessment Information**

1. Site visit documentation identifying attic information including size and spacing of framing for the existing roof structure.
2. Design drawings of the proposed system including a site plan, roof plan and connection details for the solar panels. This information will be utilized for approval and construction of the proposed system.

**B. Description of Structure:**

**Roof Framing:** Prefabricated wood trusses at 24" on center. All truss members are constructed of 2 x 4 dimensional lumber.  
**Roof Material:** Composite Asphalt Shingles  
**Roof Slopes:** 27 +/- degrees  
**Attic Access:** Accessible  
**Foundation:** Permanent

**C. Loading Criteria Used**

- **Dead Load**
  - Existing Roofing and framing = 7 psf
  - New Solar Panels and Racking = 3 psf
  - TOTAL = 10 PSF
- **Live Load** = 20 psf (reducible) – 0 psf at locations of solar panels
- **Ground Snow Load** = 0 psf
- **Wind Load** based on ASCE 7-16
  - Ultimate Wind Speed = 140 mph (based on Risk Category II)
  - Exposure Category B

*Analysis performed of the existing roof structure utilizing the above loading criteria is in accordance with the FBC 2020 7<sup>th</sup> Edition, including provisions allowing existing structures to not require strengthening if the new loads do not exceed existing design loads by 105% for gravity elements and 110% for seismic elements. This analysis indicates that the existing framing will support the additional panel loading without damage, if installed correctly.*

**D. Solar Panel Anchorage**

1. The solar panels shall be mounted in accordance with the most recent Unirac installation manual. If during solar panel installation, the roof framing members appear unstable or deflect non-uniformly, our office should be notified before proceeding with the installation.
2. The maximum allowable withdrawal force for a #14 lag screw is 252lbs per inch of penetration as identified in the National Design Standards (NDS) of timber construction specifications. Based on two screws with a minimum penetration depth of 1½", the allowable capacity per connection is greater than the design withdrawal force (demand). Considering the variable factors for the existing roof framing and installation tolerances, the connection using two #14 lag screw with a minimum of 1½" embedment will be adequate and will include a sufficient factor of safety.
3. Considering the wind speed, roof slopes, size and spacing of framing members, and condition of the roof, the panel supports shall be placed no greater than 48" on center.
4. Panel supports connections shall be staggered to distribute load to adjacent framing members.

Based on the above evaluation, this office certifies that with the racking and mounting specified, the existing roof system will adequately support the additional loading imposed by the solar system. This evaluation is in conformance with the *FBC 2020 7<sup>th</sup> Edition*, current industry standards and practice, and is based on information supplied to us at the time of this report.

Should you have any questions regarding the above or if you require further information do not hesitate to contact me.

Very truly yours,

  
Scott E. Wyssling, PE  
Florida License No. 81558

THIS PLAN HAS BEEN ELECTRONICALLY SIGNED AND SEALED BY SCOTT WYSSLING, PE USING A DIGITAL SIGNATURE AND DATE. PRINTED COPIES OF THIS DOCUMENT ARE NOT CONSIDERED SIGNED AND SEALED AND THE SIGNATURE MUST BE VERIFIED ON ANY ELECTRONIC COPIES.

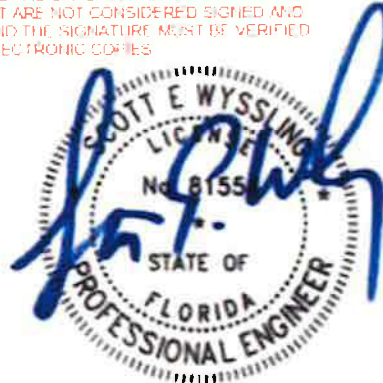

Wyssling Consulting, PLLC  
76 N Meadowbrook Drive Alpine UT 84004  
Florida License # RY34912

Date Signed 8/5/2022

**Certificate Of Completion**

Envelope Id: 0CEC16C8AA7A498E9D4F2C27AFCBFE43	Status: Completed
Subject: Tri-Party Net Metering Agreement (Virginia Delabarrera - Michael Mccade) [ELE/230407]	
Source Envelope:	
Document Pages: 32	Signatures: 5
Certificate Pages: 5	Initials: 0
AutoNav: Enabled	Envelope Originator:
Envelopeld Stamping: Enabled	Savannah Lewis
Time Zone: (UTC-05:00) Eastern Time (US & Canada)	110 SE Watula Avenue
	City Hall, Third Floor
	Ocala, FL 34471
	slewis@ocalafl.org
	IP Address: 216.255.240.104

**Record Tracking**

Status: Original	Holder: Savannah Lewis	Location: DocuSign
4/13/2023 2:52:44 PM	slewis@ocalafl.org	
Security Appliance Status: Connected	Pool: StateLocal	
Storage Appliance Status: Connected	Pool: City of Ocala - Procurement & Contracting	Location: DocuSign

**Signer Events**

William E. Sexton  
 wsexton@ocalafl.org  
 City Attorney  
 City of Ocala  
 Security Level: Email, Account Authentication (None)

**Signature**

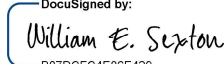
DocuSigned by:  
  
 B07DCFC4E88E429...  
 Signature Adoption: Pre-selected Style  
 Using IP Address: 216.255.240.104

**Timestamp**

Sent: 4/13/2023 3:16:44 PM  
 Viewed: 4/21/2023 2:24:32 PM  
 Signed: 4/21/2023 2:24:57 PM

**Electronic Record and Signature Disclosure:**  
 Not Offered via DocuSign

Janice Mitchell  
 jmittell@Ocalafl.org  
 CFO  
 Security Level: Email, Account Authentication (None)

DocuSigned by:  
  
 55198B43858A4E1...  
 Signature Adoption: Pre-selected Style  
 Using IP Address: 216.255.240.104

Sent: 4/21/2023 2:24:58 PM  
 Viewed: 4/21/2023 3:43:43 PM  
 Signed: 4/21/2023 3:47:03 PM

**Electronic Record and Signature Disclosure:**  
 Accepted: 4/21/2023 3:43:43 PM  
 ID: 06d3cff6-cda3-4ee5-b375-1b6aa26e8f72

Chris Gowder  
 chris.gowder@fmpa.com  
 VP of IT/OT and System Ops  
 Security Level: Email, Account Authentication (None)

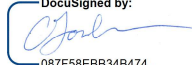
DocuSigned by:  
  
 087F58EBB34B474...  
 Signature Adoption: Uploaded Signature Image  
 Using IP Address: 38.77.131.2

Sent: 4/21/2023 3:47:04 PM  
 Viewed: 4/21/2023 3:52:44 PM  
 Signed: 4/21/2023 3:53:24 PM

**Electronic Record and Signature Disclosure:**  
 Accepted: 4/21/2023 3:52:44 PM  
 ID: d2061816-1477-41d8-b4c1-6bbc0fc365f2

In Person Signer Events	Signature	Timestamp
Editor Delivery Events	Status	Timestamp
Agent Delivery Events	Status	Timestamp
Intermediary Delivery Events	Status	Timestamp

<b>Certified Delivery Events</b>	<b>Status</b>	<b>Timestamp</b>
----------------------------------	---------------	------------------

<b>Carbon Copy Events</b>	<b>Status</b>	<b>Timestamp</b>
---------------------------	---------------	------------------

<b>Witness Events</b>	<b>Signature</b>	<b>Timestamp</b>
-----------------------	------------------	------------------

<b>Notary Events</b>	<b>Signature</b>	<b>Timestamp</b>
----------------------	------------------	------------------

<b>Envelope Summary Events</b>	<b>Status</b>	<b>Timestamps</b>
--------------------------------	---------------	-------------------

Envelope Sent	Hashed/Encrypted	4/13/2023 3:16:44 PM
Certified Delivered	Security Checked	4/21/2023 3:52:44 PM
Signing Complete	Security Checked	4/21/2023 3:53:24 PM
Completed	Security Checked	4/21/2023 3:53:24 PM

<b>Payment Events</b>	<b>Status</b>	<b>Timestamps</b>
-----------------------	---------------	-------------------

<b>Electronic Record and Signature Disclosure</b>
---

## **ELECTRONIC RECORD AND SIGNATURE DISCLOSURE**

From time to time, City of Ocala - Procurement & Contracting (we, us or Company) may be required by law to provide to you certain written notices or disclosures. Described below are the terms and conditions for providing to you such notices and disclosures electronically through the DocuSign system. Please read the information below carefully and thoroughly, and if you can access this information electronically to your satisfaction and agree to this Electronic Record and Signature Disclosure (ERSD), please confirm your agreement by selecting the check-box next to 'I agree to use electronic records and signatures' before clicking 'CONTINUE' within the DocuSign system.

### **Getting paper copies**

At any time, you may request from us a paper copy of any record provided or made available electronically to you by us. You will have the ability to download and print documents we send to you through the DocuSign system during and immediately after the signing session and, if you elect to create a DocuSign account, you may access the documents for a limited period of time (usually 30 days) after such documents are first sent to you. After such time, if you wish for us to send you paper copies of any such documents from our office to you, you will be charged a \$0.00 per-page fee. You may request delivery of such paper copies from us by following the procedure described below.

### **Withdrawing your consent**

If you decide to receive notices and disclosures from us electronically, you may at any time change your mind and tell us that thereafter you want to receive required notices and disclosures only in paper format. How you must inform us of your decision to receive future notices and disclosure in paper format and withdraw your consent to receive notices and disclosures electronically is described below.

### **Consequences of changing your mind**

If you elect to receive required notices and disclosures only in paper format, it will slow the speed at which we can complete certain steps in transactions with you and delivering services to you because we will need first to send the required notices or disclosures to you in paper format, and then wait until we receive back from you your acknowledgment of your receipt of such paper notices or disclosures. Further, you will no longer be able to use the DocuSign system to receive required notices and consents electronically from us or to sign electronically documents from us.

### **All notices and disclosures will be sent to you electronically**

Unless you tell us otherwise in accordance with the procedures described herein, we will provide electronically to you through the DocuSign system all required notices, disclosures, authorizations, acknowledgements, and other documents that are required to be provided or made available to you during the course of our relationship with you. To reduce the chance of you inadvertently not receiving any notice or disclosure, we prefer to provide all of the required notices and disclosures to you by the same method and to the same address that you have given us. Thus, you can receive all the disclosures and notices electronically or in paper format through the paper mail delivery system. If you do not agree with this process, please let us know as described below. Please also see the paragraph immediately above that describes the consequences of your electing not to receive delivery of the notices and disclosures electronically from us.

### **How to contact City of Ocala - Procurement & Contracting:**

You may contact us to let us know of your changes as to how we may contact you electronically, to request paper copies of certain information from us, and to withdraw your prior consent to receive notices and disclosures electronically as follows:

To contact us by email send messages to: [contracts@ocalafl.org](mailto:contracts@ocalafl.org)

### **To advise City of Ocala - Procurement & Contracting of your new email address**

To let us know of a change in your email address where we should send notices and disclosures electronically to you, you must send an email message to us at [contracts@ocalafl.org](mailto:contracts@ocalafl.org) and in the body of such request you must state: your previous email address, your new email address. We do not require any other information from you to change your email address.

If you created a DocuSign account, you may update it with your new email address through your account preferences.

### **To request paper copies from City of Ocala - Procurement & Contracting**

To request delivery from us of paper copies of the notices and disclosures previously provided by us to you electronically, you must send us an email to [contracts@ocalafl.org](mailto:contracts@ocalafl.org) and in the body of such request you must state your email address, full name, mailing address, and telephone number. We will bill you for any fees at that time, if any.

### **To withdraw your consent with City of Ocala - Procurement & Contracting**

To inform us that you no longer wish to receive future notices and disclosures in electronic format you may:

- i. decline to sign a document from within your signing session, and on the subsequent page, select the check-box indicating you wish to withdraw your consent, or you may;
- ii. send us an email to [contracts@ocalafl.org](mailto:contracts@ocalafl.org) and in the body of such request you must state your email, full name, mailing address, and telephone number. We do not need any other information from you to withdraw consent.. The consequences of your withdrawing consent for online documents will be that transactions may take a longer time to process..

### **Required hardware and software**

The minimum system requirements for using the DocuSign system may change over time. The current system requirements are found here: <https://support.docusign.com/guides/signer-guide-signing-system-requirements>.

### **Acknowledging your access and consent to receive and sign documents electronically**

To confirm to us that you can access this information electronically, which will be similar to other electronic notices and disclosures that we will provide to you, please confirm that you have read this ERSD, and (i) that you are able to print on paper or electronically save this ERSD for your future reference and access; or (ii) that you are able to email this ERSD to an email address where you will be able to print on paper or save it for your future reference and access. Further, if you consent to receiving notices and disclosures exclusively in electronic format as described herein, then select the check-box next to ‘I agree to use electronic records and signatures’ before clicking ‘CONTINUE’ within the DocuSign system.

By selecting the check-box next to ‘I agree to use electronic records and signatures’, you confirm that:

- You can access and read this Electronic Record and Signature Disclosure; and
- You can print on paper this Electronic Record and Signature Disclosure, or save or send this Electronic Record and Disclosure to a location where you can print it, for future reference and access; and
- Until or unless you notify City of Ocala - Procurement & Contracting as described above, you consent to receive exclusively through electronic means all notices, disclosures, authorizations, acknowledgements, and other documents that are required to be provided or made available to you by City of Ocala - Procurement & Contracting during the course of your relationship with City of Ocala - Procurement & Contracting.