

**T-HANGAR LEASE AGREEMENT**

**THIS T-HANGAR LEASE AGREEMENT** ("Agreement" or "Lease") is entered into by and between the **CITY OF OCALA**, a Florida municipal corporation ("City"), and **Shawn Simms** ("Lessee").

**WHEREAS**, the City of Ocala is the owner and operator of the Ocala International Airport (the "Airport") located in Ocala, Marion County, Florida;

**WHEREAS**, City has T-Hangar units available for lease at the Airport;

**WHEREAS**, Lessee desires to lease a T-Hangar unit at Airport from City; and

**WHEREAS**, City is willing to lease to Lessee the T-Hangar unit identified in Section 1 below at the Airport subject to the terms and conditions set forth in this Agreement.

**NOW THEREFORE**, in consideration of the foregoing Recitals, the following mutual covenants and conditions, and other good and valuable consideration, City and Lessee agree as follows:

**TERMS AND CONDITIONS:**

1. **LEASED PREMISES.** City hereby leases to Lessee, and Lessee leases from City, T-Hangar Unit Number: **T-82** located at the Ocala International Airport and more particularly shown in **Exhibit A** attached hereto (the "Hangar" or "Leased Premises").
  - A. City reserves the right to deny access to the Airport and its facilities to any person, firm, or corporation that fails or refuses to obey and comply with the rules and regulations contained herein.
  - B. City shall purchase a Hangar lock for use on Hangar doors. One key will be provided to and maintained by Lessee. The master key will be maintained by the Airport Director or authorized representative. Under no circumstances shall Lessee be permitted to replace the Hangar lock provided by City. Use of any other lock on Hangar doors shall constitute a breach of this Lease. Loss of the Hangar lock or Lessee's Hangar lock key shall result in the City's assessment of either a re-key and/or lock replacement charge in accordance with the current Airport Fee Schedule which shall become due and payable as part of Lessee's monthly rent on the next monthly rental cycle.
  - C. City, through its officers, agents, servants or employees, reserves the right to enter the Leased Premises at any time to perform any and all duties or obligations which City is authorized or required to do under the terms of this Lease or to perform its governmental duties under federal, state, or local rules, regulations, and laws (including, but not limited to, inspections under applicable health, mechanical, building, electrical, plumbing, and Fire Codes) or other health, safety, and general welfare regulations. All routine inspections shall be done during normal business hours and in conformity with City's Airport policies (including those requiring two employees to be present during inspections). City shall leave a notice on the premises following inspections indicating the time and date of the inspection, who was present, and the purpose of the inspection; provided, however, no notice shall be required if: (a) the inspection was a law enforcement purpose; or (b) the City had previously mailed a notice to Lessee, at least a week prior to the inspection, advising Lessee of the week in which the inspection would occur and the purpose of the inspection.

## 2. **EFFECTIVE DATE, TERM, AND TERMINATION.**

- A. **Effective Date and Lease Term.** This Lease shall commence on **July 1<sup>st</sup>, 2024**, shall become effective on the date fully executed by both Parties (the "Effective Date"), and shall continue in effect from month-to-month thereafter (the "Lease Term") unless and until terminated by either party as provided herein.
- B. **Termination.** This Lease shall be terminable at will by either party, without cause, upon providing advance written notice to the other party no less than **THIRTY (30) DAYS'** prior to termination. Termination of this Lease shall have no effect upon the rights or responsibilities of the parties accruing prior to termination.
- (1) Should Lessee be declared bankrupt, incompetent, or become deceased, this Lease shall immediately terminate and shall not be considered to be part of Lessee's estate nor shall it become an asset of any appointed or assigned guardian, trustee, or receiver.
- (2) City shall have the right to terminate this Lease and retake possession of the Leased Premises should Lessee fail to make timely payment of rent, fail to provide proof of required insurance, use the Leased Premises for any illegal or unauthorized purpose, file bankruptcy, abandon or leave the Leased Premises vacant or unoccupied for **ONE HUNDRED TWENTY (120) DAYS**, or violates any of the terms and conditions of this Lease.
- (3) Upon termination or expiration of this Lease, Lessee shall peaceably vacate the Leased Premises.
- C. **Remedies.** If any default occurs under this Lease, City shall have the right to pursue all remedies available at law or equity, including the termination of this Lease and all rights of Lessee hereunder. Notwithstanding City's termination of the Lease, Lessee shall remain liable to City for all claims for damages, costs or attorneys' fees arising prior to such termination.

## 3. **CONSIDERATION.**

- A. **Rent.** As rent for the use of the Leased Premises, Lessee shall pay to City monthly, in advance, the amount of **\$ 545.92 /Month**. Any other payments made by Lessee under this Lease shall be considered additional rent, regardless of whether the payments are so designated. The term "Rent," as referenced herein, shall include monthly rent and additional rent. City shall have the same remedies for Lessee's failure to pay additional rent as it does for Lessee's failure to pay monthly rent.
- B. **Payment of Rent.** Monthly rental payments are due on or before the first (1<sup>st</sup>) day of each month without billing of Lessee by City. Unless expressly authorized by the City, rent shall be made payable to the "City of Ocala" and shall be delivered or paid in person to: **City of Ocala, c/o Ocala International Airport, 1770 SW 60<sup>th</sup> Avenue, Suite 600, Ocala, Florida 34474**. Payments made by credit card may be subject to a credit card processing fee.
- C. **Late Charge.** Rent shall be considered past due if City has not received full payment by the fifteenth (15<sup>th</sup>) day of the month for which payment is due. Without limiting City's termination rights as provided by this Lease, City shall assess a late penalty charge in the amount of **TWENTY-FIVE AND NO/100 DOLLARS (\$25.00)**.
- D. **Adjustments to Rent.** City reserve the right to increase the amount of rent from time to time, in its sole discretion, and shall provide written notice of said increase to Lessee no less than **THIRTY (30) DAYS** prior to the effective date of the rental increase.

4. **USE OF LEASED PREMISES.** Unless otherwise authorized by City in writing, Lessee shall use the Leased Premises and associated utilities on a non-commercial basis only for the storage, operation, and maintenance of the following Federal Aviation Administration ("FAA")-registered aircraft:

**Year, Make and Model of Aircraft:** 2007 Cirrus SR22

**N#:** 312SR

- A. Any change to the aircraft expressly identified in this Section shall be reported in writing to the Airport Director within **TEN (10) DAYS** thereof.
- B. The Leased Premises are to be used only for the storage of aircraft and other aviation-related items owned or leased by Lessee. Lessee's use of the Leased premises for any other purpose shall constitute a material breach of this Lease.
- C. Lessee shall not use the Leased Premises for any commercial purposes. The storage of aircraft used by Lessee in connection with its customary non-aviation related business shall not be considered to be a commercial purpose. Under no circumstances will the sale of goods or services by Lessee from the Leased Premises be authorized.
- D. Lessee may maintain a small refrigerator in the Leased Premises, but only if the wiring capacity of the Leased Premises can support such usage.
- E. City reserves the right to assess, as additional rent, charges for extraordinary consumption of utilities by Lessee, as reasonably determined by City in its sole discretion.
- F. All aircraft stored in the Leased Premises must be airworthy. Short-term storage of non-operational aircraft for the purposes of maintenance, repair or refurbishment shall be allowed. However, aircraft may not be inoperable or under repair for a period greater than **ONE HUNDRED TWENTY (120) DAYS**, consecutively without City approval, unless such condition is caused by circumstances beyond Lessee's control (e.g., inability to obtain parts).
- G. Lessee shall abide by all Airport rules and regulations, minimum standards, City ordinances, applicable federal and state statutes, and regulations of the FAA, as they may from time to time be amended, including environmental laws regarding the handling, discharge, release and dumping of any hazardous substance, and such rules, regulations, and ordinances are incorporated by reference herein and made a part hereof.
- H. No explosives or combustible materials shall be permitted within or about the Hangar except for fuel in aircraft tanks or small containers of lubricants, cleaning materials, and other aviation-related materials stored in EPA or local Fire Marshall approved containers or cabinets.
- I. No refueling of the aircraft is allowed while any part of the aircraft remains inside the Hangar.
- J. The exclusive means of access to the Leased Premises shall be through the Piedmont Hawthorne gate via the T-Hangar access road.
- K. With the exception of loading or unloading of aircraft on the FBO apron, Lessee shall not operate any motor vehicle on the Airport apron, runway system, or Taxiway E system at any time.
- L. Lessee shall be allowed to park its motor vehicle in the Hangar while Lessee is in the Hangar or when the aircraft is out and in use. Otherwise, all motor vehicles belonging to Lessee or its guests or licensees shall be parked only in the public parking area outside of the fence.

- M. Lessee shall not allow its aircraft engine to be run inside a Hangar.
5. **MAINTENANCE OF THE LEASED PREMISES.** Lessee shall maintain the Leased Premises and all improvements in a condition that is clean, free of debris, safe, sanitary, and in good repair and shall not accumulate or permit the accumulation of any trash, refuse or debris or of anything that is unsightly or which creases a fire hazard or nuisance or causes an inconvenience to adjoining properties.
- A. City shall maintain the structural integrity of the Hangar, including doors, and shall provide Lessee with access to water, electricity and normal building maintenance.
  - B. City shall provide and maintain one (1) fire extinguisher in the Hangar. Should the City's inspection of the premises reveal that the City-owned fire extinguisher is missing, Lessee shall be responsible for replacement of the fire extinguisher with a model of comparable size and quality, at its sole expense.
  - C. Lessee shall maintain the interior of the Hangar in a neat and orderly condition, and shall keep the Hangar floor clean and clear of excess oil grease, or toxic chemicals.
  - D. Lessee shall make no structural, electrical, or any other modifications or alterations to the Leased Premises, or remove any structures, wiring, plumbing or other facilities, without first submitting to City the plans and specifications for the proposed modifications and obtaining a written approval from City (which approval may be subject to reasonable conditions imposed by City) and without first obtaining all applicable permits from governments with jurisdiction over the activities.
  - E. All fixtures, alterations, changes and improvements built, constructed or placed on the Leased Premises by Lessee shall, at City's option, become the property of City and remain on the Leased Premises at the expiration or earlier termination of this Lease, or City may require Lessee to restore the Leased Premises, in whole or in part, to its condition prior to such fixtures, alterations, changes or improvements.
  - F. Lessee shall be responsible for all damages to the premises caused by Lessee or arising from Lessee's use of the premises, except those caused by "acts of God," or those arising from normal wear and tear or from deliberate or negligent acts of City or its employees. If Lessee fails to promptly repair any damages for which it is responsible hereunder after notification by City, City may, but shall not be obligated to, make repairs at Lessee's expense which shall become due and payable as part of Lessee's rent on the next monthly billing cycle.
  - G. Upon termination of this Lease by either party, a joint inspection of the Leased Premises shall be conducted and any unsatisfactory conditions shall be documented on the T-Hangar Check-Out Form attached hereto as **Exhibit B**. Should Lessee fail to promptly repair any damages or replace any items for which it is responsible hereunder after City provides notice and demand for same, City may, but shall not be obligated to, make repairs at Lessee's expense. City reserves the right to deduct the cost of any such repairs from Lessee's refundable hangar deposit.
6. **AIRCRAFT MAINTENANCE AND REPAIRS.** The following provisions shall govern the short-term maintenance, repair or refurbishment of aircraft stored in the Leased Premises.
- A. All repair of aircraft shall be governed by and performed in compliance with Part 43 of the Federal Aviation Administration Regulations (14 C.F.R. Part 43). Those terms defined in Part 43 shall have the same meaning in this paragraph.

- B. Hazardous activities, including, but not limited to, smoking, welding, painting, doping, open fuel lines, open flames, or the application of hazardous substances are expressly prohibited in the Hangar.
- C. Minor aircraft self-maintenance such as would normally be performed by an aircraft owner by himself or with his own employees without the benefit of an aircraft mechanic shall be allowed to be performed in the Hangar.
- D. Lessee's possessing a valid mechanic's certificate or who are otherwise authorized by the FAA shall be permitted to perform any maintenance and repairs on its own aircraft unless: (1) the work constitutes powerplant major repairs; or (2) the work being performed in the Hangar will require the installation of a fire-suppression system in the Hangar.
- E. Lessee's possessing a valid mechanic's certificate or who are otherwise authorized by the FAA shall be permitted to perform maintenance and repairs on aircraft belonging to others only pursuant to the City's Airport Minimum Standards including applicable liability insurance requirements.
- F. The provisions of this Section shall not apply to experimental aircraft construction and maintenance to the extent they are exempt from the provisions of Part 43 of the Federal Aviation Administration Regulations, but such activities shall be subject to other applicable Federal Aviation Administration Regulations (e.g., 14 C.F.R. §65.104).

7. **INDEMNIFICATION AND INSURANCE.**

- A. **Indemnity.** Lessee agrees to indemnify and hold City and its elected officials, employees, agents, and volunteers harmless from and against any and all liabilities, judgments, costs, damages, expenses, claims, actions or demands of any kind and nature, by any person whatsoever, including, without limitation, personal property damage, injury or death to a person arising out of the activities of Lessee, its agents, employees, contractors or invitees on the Leased Premises, except those caused by the deliberate or negligent act or failure to act of City or its agents or representatives.
- B. **Insurance.** The City may maintain fire and casualty insurance on the premises for its benefit but such insurance shall not cover any property of Lessee and all proceeds payable thereunder shall be the sole property of City. If the Leased Premises are damaged by any casualty not the result of the negligent or deliberate acts of Lessee, its licensees, invitees, and guests, City may terminate this Lease or may, at its option, repair the damage. If City elects to repair, rent shall be abated until repairs are completed.
- C. Lessee shall at its sole cost repair any damage to the premises resulting from negligent or deliberate acts of Lessee, its agents, employees, contractors, invitees and guests.
- D. City shall not be responsible for any damage to any property of Lessee (including, without limitation, aircraft) or of others located on the Leased Premises, nor for the loss of or damage to any property of Lessee or of others by theft or otherwise. City shall not be liable for any injury or damage to persons or property resulting from fire, smoke, explosion, falling plaster, steam, gas, electricity, water, rain, or leaks from any part of the premises or from the pipes, appliances or plumbing works or from the roof, street or subsurface or from any other place of by dampness or by any other cause of whatsoever nature. City shall not be liable for any latent defect in the Leased Premises or in the building of which they form a part. All property of Lessee kept or stored on the Leased Premises shall be so kept or stored at the risk of Lessee only and Lessee shall hold City harmless from any and all claims arising out of damage to

same, including subrogation claims by Lessee’s insurance carriers, except those caused by the deliberate or negligent act or failure to act of City or its agents or representatives.

**8. CONDITION OF PREMISES; NO WARRANTIES.**

A. City represents and warrants that the Leased Premises comply with applicable building and fire codes in effect at the time of its construction, and that any changes in such codes since such time do not require additional improvements (except upon a rebuilding or renovation thereof).

B. EXCEPT AS SET FORTH IN THE PRECEDING SUBPARAGRAPH,

(1) LESSEE ACKNOWLEDGES THAT BY ENTERING INTO POSSESSION OF THE PREMISES, IT SHALL BE DEEMED: TO HAVE INSPECTED THE PREMISES; AND TO HAVE ACCEPTED THE PREMISES “AS IS,” “WITH ALL FAULTS” OF ANY NATURE WHATSOEVER; AND

(2) LESSEE ACKNOWLEDGES THAT NEITHER CITY NOR ANY AGENT OF CITY HAS MADE ANY WARRANTY OR REPRESENTATION, OF ANY NATURE WHATSOEVER, EXPRESS OR IMPLIED, CONCERNING THE PREMISES, INCLUDING, WITHOUT LIMITATION, SOIL CONDITIONS, ENVIRONMENTAL CONDITIONS, BUILDING CONSTRUCTION OR SUITABILITY OF THE PREMISES FOR LESSEE’S PURPOSES.

9. **NOTICES.** All notices required or permitted under this Agreement shall be given in writing and shall be deemed sufficiently served if delivered by registered or certified mail, with return receipt requested; or delivered personally; or delivered via electronic mail (as provided below) and followed with delivery of a hard copy. All notices shall be addressed to the respective parties as follows:

If to Lessee: At the address, fax number, or e-mail address Identified underneath Lessee’s signature line.

If to City of Ocala: City of Ocala – Ocala International Airport  
1770 SW 60<sup>th</sup> Avenue, Suite 600  
Ocala, Florida 34474  
Fax: 352-861-2227

Copy to: Daphne M. Robinson, Esq. – Contracting Officer  
City of Ocala  
110 SE Watula Avenue, Third Floor  
Ocala, Florida 34471  
Phone: 352-629-8343  
Email: [notices@ocalafl.org](mailto:notices@ocalafl.org)

**10. MISCELLANEOUS PROVISIONS.**

A. **Governing Law.** This Lease is and shall be deemed to be a contract entered and made pursuant to the laws of the State of Florida and shall in all respects be governed, construed, applied and enforced in accordance with the laws of the State of Florida.

B. **Jurisdiction and Venue.** The parties acknowledge that a majority of the negotiations, anticipated performance and execution of this Lease occurred or shall occur in Marion County, Florida. Any civil action or legal proceeding arising out of or relating to this Lease shall be brought only in the courts of record of the State of Florida in Marion County or the United States District Court, Middle District of Florida, Ocala Division. Each party consents to the exclusive jurisdiction of such court in any such civil action or legal proceeding and waives

any objection to the laying of venue of any such civil action or legal proceeding in such court and/or the right to bring an action or proceeding in any other court. Service of any court paper may be effected on such party by mail, as provided in this Lease, or in such other manner as may be provided under applicable laws, rules of procedures or local rules.

- C. **Jury Waiver.** IN ANY CIVIL ACTION, COUNTERCLAIM, OR PROCEEDING, WHETHER AT LAW OR IN EQUITY, WHICH ARISES OUT OF, CONCERNS, OR RELATES TO THIS LEASE, ANY AND ALL TRANSACTIONS CONTEMPLATED HEREUNDER, THE PERFORMANCE HEREOF, OR THE RELATIONSHIP CREATED HEREBY, WHETHER SOUNDING IN CONTRACT, TORT, STRICT LIABILITY, OR OTHERWISE, TRIAL SHALL BE TO A COURT OF COMPETENT JURISDICTION AND NOT TO A JURY. EACH PARTY HEREBY IRREVOCABLY WAIVES ANY RIGHT IT MAY HAVE TO A TRIAL BY JURY. NEITHER PARTY HAS MADE OR RELIED UPON ANY ORAL REPRESENTATIONS TO OR BY ANY OTHER PARTY REGARDING THE ENFORCEABILITY OF THIS PROVISION. EACH PARTY HAS READ AND UNDERSTANDS THE EFFECT OF THIS JURY WAIVER PROVISION.
- D. **Attorney's Fees.** If any civil action, arbitration or other legal proceeding is brought for the enforcement of this Lease, or because of an alleged dispute, breach, default or misrepresentation in connection with any provision of this Lease, the successful or prevailing party shall be entitled to recover reasonable attorneys' fees, sales and use taxes, court costs and all expenses reasonably incurred even if not taxable as court costs (including, without limitation, all such fees, taxes, costs and expenses incident to arbitration, appellate, bankruptcy and post-judgment proceedings), incurred in that civil action, arbitration or legal proceeding, in addition to any other relief to which such party or parties may be entitled. Attorneys' fees shall include, without limitation, paralegal fees, investigative fees, administrative costs, sales and use taxes and all other charges reasonably billed by the attorney to the prevailing party.
- E. **Amendment.** No amendment to this Lease shall be effective except those agreed to in writing and signed by both parties to this Lease.
- F. **Severability of Illegal Provisions.** Wherever possible, each provision of this Lease shall be interpreted in such a manner as to be effective and valid under the applicable law. Should any portion of this Lease be declared invalid for any reason, such declaration shall have no effect upon the remaining portions of this Lease.
- G. **Rights of Third Parties.** Nothing in this Lease, whether express or implied, is intended to confer any rights or remedies under or because of this Lease on any persons other than the parties hereto and their respective legal representatives, successors and permitted assigns. Nothing in this Lease is intended to relieve or discharge the obligation or liability of any third persons to any party to this Lease, nor shall any provision give any third persons any right of subrogation or action over or against any party to this Lease.
- H. **Assignment.** Neither party may assign this Lease or the rights and obligations thereunder to any third party without the prior express written approval of the other party, which shall not be unreasonably withheld.
- I. **No Waiver of Sovereign Immunity.** Nothing herein is intended to waive sovereign immunity by the City to which sovereign immunity may be applicable, or of any rights or

limits of liability existing under Florida Statute § 768.28. This term shall survive the termination of all performance or obligations under this Lease and shall be fully binding until any proceeding brought under this Lease is barred by any applicable statute of limitations.

- J. **Public Records.** **IF LESSEE HAS QUESTIONS REGARDING THE APPLICATION OF CHAPTER 119, FLORIDA STATUTES, TO THE LESSEE'S DUTY TO PROVIDE PUBLIC RECORDS RELATING TO THE LEASE, CONTACT THE CUSTODIAN OF PUBLIC RECORDS AT: City of Ocala, Office of The City Clerk; City Hall, 110 SE Watula Avenue, Ocala, FL 34471; Phone: 352-629-8266; Email: [clerk@ocalafl.org](mailto:clerk@ocalafl.org).**
- K. **Electronic Signatures.** City, if and by offering an electronic signature in any form whatsoever, will accept and agree to be bound by said electronic signature to all terms and conditions of this Lease. Further, a duplicate or copy of the Lease that contains a duplicated or non-original signature will be treated the same as an original, signed copy of this original Lease for all purpose.
- L. **Entire Lease.** This Lease, including exhibits, (if any) constitutes the entire Lease between the parties hereto with respect to the subject matter hereof. There are no other representations, warranties, promises, Leases or understandings, oral, written or implied, among the Parties, except to the extent reference is made thereto in this Lease. No course of prior dealings between the parties and no usage of trade shall be relevant or admissible to supplement, explain, or vary any of the terms of this Lease. No representations, understandings, or Leases have been made or relied upon in the making of this Lease other than those specifically set forth herein.
- M. **Legal Authority.** Each person signing this Lease on behalf of either party individually warrants that he or she has full legal power to execute this Lease on behalf of the party for whom he or she is signing, and to bind and obligate such party with respect to all provisions contained in this Lease.

**[REMAINDER OF PAGE INTENTIONALLY BLANK. SIGNATURE PAGE TO FOLLOW]**



**CONTRACT#: AIR/240835**

**IN WITNESS WHEREOF**, the parties have executed this Agreement on the dates set forth below.

**ATTEST**

DocuSigned by:  
*Angel B. Jacobs*  
Angel B. Jacobs  
City Clerk

**CITY OF OCALA**

  
Matthew Grow, Airport Director  
(Pursuant to City Council Resolution:  
2003-57, adopted April 8, 2003)  
*6-27-24*  
Date Signed

**Approved as to form and legality**

DocuSigned by:  
*William E. Sexton*  
William E. Sexton  
City Attorney

**LESSEE**

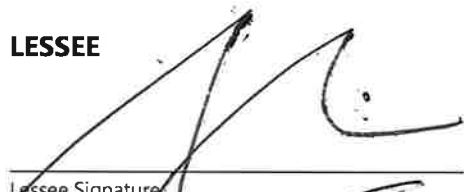
  
Lessee Signature  
*Shawn Sims*  
Printed Name of Lessee  
*6/28/24*  
Date Signed

*3336 South East 15th*  
Street Address of Lessee

*Ocala*  
City, State, and Zip Code of Lessee

Phone Number of Lessee  
*813 325 1877*  
Alternate Phone Number of Lessee

*Shawn.Sims*  
E-Mail Address of Lessee

**EXHIBIT A**

INSERT EXHIBIT A DOCUMENT HERE



# T Hangar Campus Layout

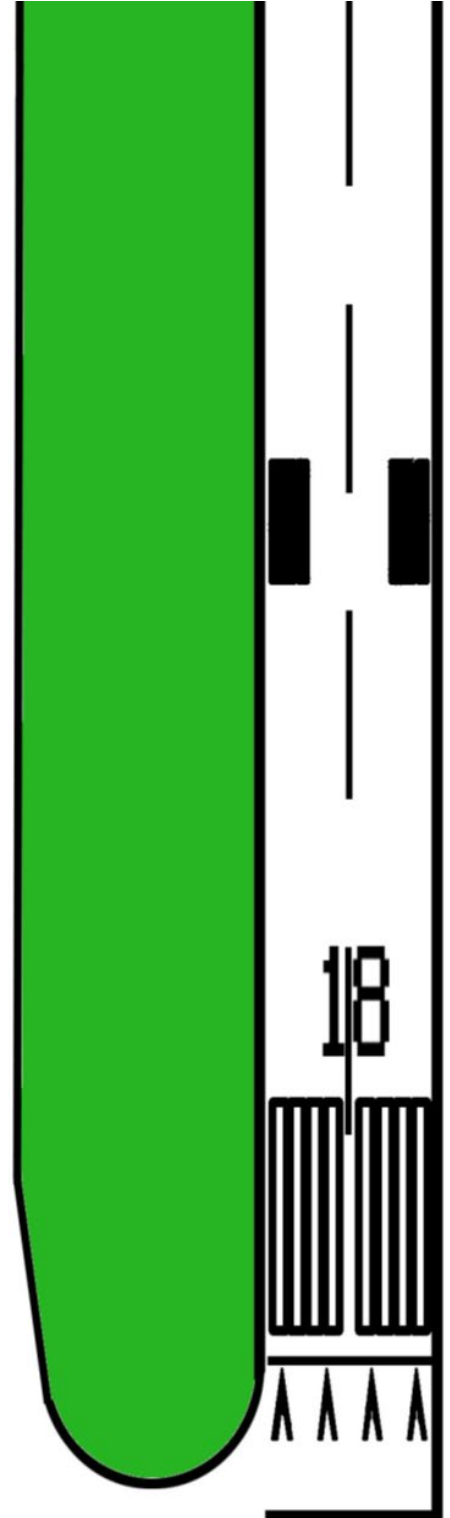
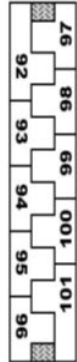
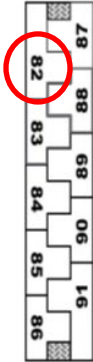
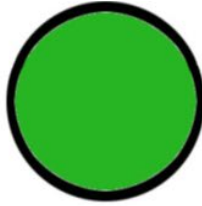
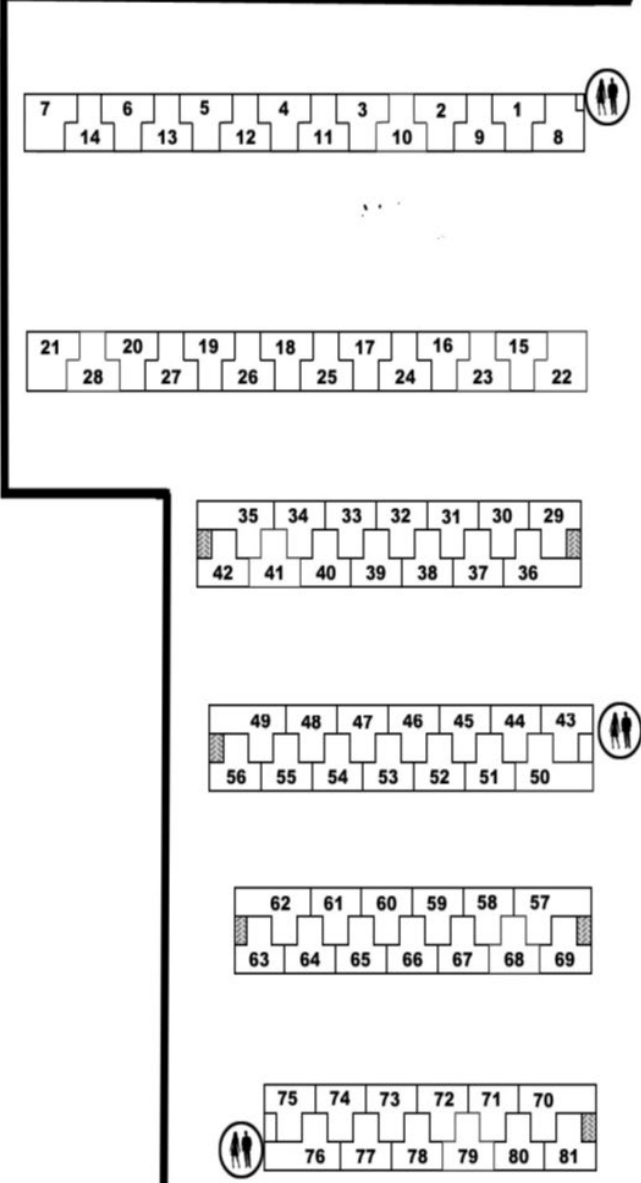

**EXHIBIT B**

**T-HANGAR CHECK OUT FORM**

**Lessee Name:** Shawn Simms

**T-Hangar No.:** T-82

Move Out Date: \_\_\_\_\_

Inspection Date: \_\_\_\_\_

Time Of Inspection: \_\_\_\_\_

Inspected By: \_\_\_\_\_

Unless otherwise noted, the premises is in clean, good working order and undamaged.

Keys/Lock/Fire Extinguisher	<input type="checkbox"/>
Cleanliness of Hangar	<input type="checkbox"/>
Damage to space	<input type="checkbox"/>
Grease/Oil/Chemicals	<input type="checkbox"/>
Furniture/equipment Left in Hangar	<input type="checkbox"/>

REMARKS: \_\_\_\_\_

\_\_\_\_\_

\_\_\_\_\_

Signatures:

**Airport:** \_\_\_\_\_

**Lessee:** \_\_\_\_\_

 United States Department of Transportation

[About DOT](#)   [Our Activities](#)   [Areas of Focus](#)

# FAA REGISTRY

## N-Number Inquiry Results

**N-NUMBER ENTERED: 312SR**

### AIRCRAFT DESCRIPTION

Serial Number	2427	Status	Valid
Manufacturer Name	CIRRUS DESIGN CORP	Certificate Issue Date	01/12/2024
Model	SR22	Expiration Date	01/31/2031
Type Aircraft	Fixed Wing Single-Engine	Type Engine	Reciprocating
Pending Number Change	None	Dealer	No
Date Change Authorized	None	Mode S Code (base 8 / Oct)	50647737
MFR Year	2007	Mode S Code (Base 16 / Hex)	A34FDF
Type Registration	LLC	Fractional Owner	NO

### REGISTERED OWNER

Name	STORM CONSULTING ENTERPRISES LLC		
Street	20841 HWY 69 S		
City	TYLER	State	TEXAS
County	SMITH	Zip Code	75703
Country	UNITED STATES		

### AIRWORTHINESS

Type Certificate Data Sheet	None	Type Certificate Holder	None
Engine Manufacturer	CONT MOTOR	Classification	Standard
Engine Model	IO-550-N	Category	Normal
A/W Date	03/29/2007	Exception Code	No

The information contained in this record should be the most current Airworthiness information available in the historical aircraft record. However, this data alone does not provide the basis for a determination regarding the airworthiness of an aircraft or the current aircraft configuration. For specific information, you may request a copy of the aircraft record at <https://aircraft.faa.gov/e.gov/ND/>

**OTHER OWNER NAMES**

None

**TEMPORARY CERTIFICATES**

None

**FUEL MODIFICATIONS**

None

**DEREGISTERED AIRCRAFT**

None

**The duration of aircraft registration certificates has been extended up to 7 years. The Registry will be issuing revised certificates in batches based on the former expiration date. For verification purposes, even though the expiration date on the registration certificate may not match the expiration date in the FAA Aircraft Registration database, any registration certificate displaying an expiration date of January 31, 2023 or later is still valid. This applies to all foreign Civil Aviation Authorities or anyone else with a verification need.**

***You are accessing a U.S. Government authorized information system, which includes (1) this computer, (2) this computer network, (3) all computers connected***

***to this network, (4) all devices and storage media attached to this network or to a computer on this network, and (5) all cloud services and hosting environments supporting this information system. This information system is provided for U.S. Government-authorized use only.***

***Unauthorized or improper use of this system may result in disciplinary action, as well as civil and criminal penalties.***

***By logging in and using this information system, you understand and consent to the following:***

- You have no reasonable expectation of privacy regarding communications or data transiting or stored on this information system.***
- At any time, and for any lawful Government purpose, communication between the user and this information system, data transiting to/from the system, or stored on this system is subject to monitoring, interception, and search.***
- Any communications or data transiting or stored on this information system may be disclosed or used for any lawful Government purpose.***



**Certificate Of Completion**

Envelope Id: 663228C67A9E49CFAB6348A04B5CC907	Status: Completed
Subject: Signature-(AIR) 240835 T- Hangar Lease Agreement_ Shawn Simms	
Source Envelope:	
Document Pages: 16	Signatures: 2
Certificate Pages: 5	Initials: 0
AutoNav: Enabled	Envelope Originator:
Envelope Stamping: Enabled	April Adolf
Time Zone: (UTC-05:00) Eastern Time (US & Canada)	110 SE Watula Avenue
	City Hall, Third Floor
	Ocala, FL 34471
	aadolof@ocalafl.gov
	IP Address: 216.255.240.104

**Record Tracking**

Status: Original	Holder: April Adolf	Location: DocuSign
6/28/2024 4:30:07 PM	aadolof@ocalafl.gov	
Security Appliance Status: Connected	Pool: StateLocal	
Storage Appliance Status: Connected	Pool: City of Ocala - Procurement & Contracting	Location: DocuSign

**Signer Events**

William E. Sexton  
 wsexton@ocalafl.org  
 City Attorney  
 City of Ocala  
 Security Level: Email, Account Authentication (None)

**Signature**

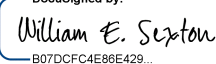
DocuSigned by:  
  
 B07DCFC4E86E429...  
 Signature Adoption: Pre-selected Style  
 Using IP Address: 216.255.240.104

**Timestamp**

Sent: 6/28/2024 4:54:51 PM  
 Viewed: 7/2/2024 10:07:03 AM  
 Signed: 7/2/2024 10:07:39 AM

**Electronic Record and Signature Disclosure:**

Not Offered via DocuSign

Angel B. Jacobs  
 ajacobs@ocalafl.org  
 City Clerk  
 Security Level: Email, Account Authentication (None)

DocuSigned by:  
  
 8DB3574C28E54A5...  
 Signature Adoption: Pre-selected Style  
 Using IP Address: 216.255.240.104

Sent: 7/2/2024 10:07:40 AM  
 Viewed: 7/2/2024 10:19:03 AM  
 Signed: 7/2/2024 10:26:40 AM

**Electronic Record and Signature Disclosure:**

Accepted: 7/2/2024 10:19:03 AM  
 ID: a8a08245-50b9-4a3c-8e52-fe197ea4376c

In Person Signer Events	Signature	Timestamp
Editor Delivery Events	Status	Timestamp
Agent Delivery Events	Status	Timestamp
Intermediary Delivery Events	Status	Timestamp
Certified Delivery Events	Status	Timestamp
Carbon Copy Events	Status	Timestamp
Witness Events	Signature	Timestamp
Notary Events	Signature	Timestamp
Envelope Summary Events	Status	Timestamps

<b>Envelope Summary Events</b>	<b>Status</b>	<b>Timestamps</b>
Envelope Sent	Hashed/Encrypted	6/28/2024 4:54:51 PM
Certified Delivered	Security Checked	7/2/2024 10:19:03 AM
Signing Complete	Security Checked	7/2/2024 10:26:40 AM
Completed	Security Checked	7/2/2024 10:26:40 AM

<b>Payment Events</b>	<b>Status</b>	<b>Timestamps</b>
-----------------------	---------------	-------------------

<b>Electronic Record and Signature Disclosure</b>
---

## **ELECTRONIC RECORD AND SIGNATURE DISCLOSURE**

From time to time, City of Ocala - Procurement & Contracting (we, us or Company) may be required by law to provide to you certain written notices or disclosures. Described below are the terms and conditions for providing to you such notices and disclosures electronically through the DocuSign system. Please read the information below carefully and thoroughly, and if you can access this information electronically to your satisfaction and agree to this Electronic Record and Signature Disclosure (ERSD), please confirm your agreement by selecting the check-box next to 'I agree to use electronic records and signatures' before clicking 'CONTINUE' within the DocuSign system.

### **Getting paper copies**

At any time, you may request from us a paper copy of any record provided or made available electronically to you by us. You will have the ability to download and print documents we send to you through the DocuSign system during and immediately after the signing session and, if you elect to create a DocuSign account, you may access the documents for a limited period of time (usually 30 days) after such documents are first sent to you. After such time, if you wish for us to send you paper copies of any such documents from our office to you, you will be charged a \$0.00 per-page fee. You may request delivery of such paper copies from us by following the procedure described below.

### **Withdrawing your consent**

If you decide to receive notices and disclosures from us electronically, you may at any time change your mind and tell us that thereafter you want to receive required notices and disclosures only in paper format. How you must inform us of your decision to receive future notices and disclosure in paper format and withdraw your consent to receive notices and disclosures electronically is described below.

### **Consequences of changing your mind**

If you elect to receive required notices and disclosures only in paper format, it will slow the speed at which we can complete certain steps in transactions with you and delivering services to you because we will need first to send the required notices or disclosures to you in paper format, and then wait until we receive back from you your acknowledgment of your receipt of such paper notices or disclosures. Further, you will no longer be able to use the DocuSign system to receive required notices and consents electronically from us or to sign electronically documents from us.

### **All notices and disclosures will be sent to you electronically**

Unless you tell us otherwise in accordance with the procedures described herein, we will provide electronically to you through the DocuSign system all required notices, disclosures, authorizations, acknowledgements, and other documents that are required to be provided or made available to you during the course of our relationship with you. To reduce the chance of you inadvertently not receiving any notice or disclosure, we prefer to provide all of the required notices and disclosures to you by the same method and to the same address that you have given us. Thus, you can receive all the disclosures and notices electronically or in paper format through the paper mail delivery system. If you do not agree with this process, please let us know as described below. Please also see the paragraph immediately above that describes the consequences of your electing not to receive delivery of the notices and disclosures electronically from us.

### **How to contact City of Ocala - Procurement & Contracting:**

You may contact us to let us know of your changes as to how we may contact you electronically, to request paper copies of certain information from us, and to withdraw your prior consent to receive notices and disclosures electronically as follows:

To contact us by email send messages to: [contracts@ocalafl.org](mailto:contracts@ocalafl.org)

### **To advise City of Ocala - Procurement & Contracting of your new email address**

To let us know of a change in your email address where we should send notices and disclosures electronically to you, you must send an email message to us at [contracts@ocalafl.org](mailto:contracts@ocalafl.org) and in the body of such request you must state: your previous email address, your new email address. We do not require any other information from you to change your email address.

If you created a DocuSign account, you may update it with your new email address through your account preferences.

### **To request paper copies from City of Ocala - Procurement & Contracting**

To request delivery from us of paper copies of the notices and disclosures previously provided by us to you electronically, you must send us an email to [contracts@ocalafl.org](mailto:contracts@ocalafl.org) and in the body of such request you must state your email address, full name, mailing address, and telephone number. We will bill you for any fees at that time, if any.

### **To withdraw your consent with City of Ocala - Procurement & Contracting**

To inform us that you no longer wish to receive future notices and disclosures in electronic format you may:

- i. decline to sign a document from within your signing session, and on the subsequent page, select the check-box indicating you wish to withdraw your consent, or you may;
- ii. send us an email to [contracts@ocalafl.org](mailto:contracts@ocalafl.org) and in the body of such request you must state your email, full name, mailing address, and telephone number. We do not need any other information from you to withdraw consent.. The consequences of your withdrawing consent for online documents will be that transactions may take a longer time to process..

### **Required hardware and software**

The minimum system requirements for using the DocuSign system may change over time. The current system requirements are found here: <https://support.docusign.com/guides/signer-guide-signing-system-requirements>.

### **Acknowledging your access and consent to receive and sign documents electronically**

To confirm to us that you can access this information electronically, which will be similar to other electronic notices and disclosures that we will provide to you, please confirm that you have read this ERSD, and (i) that you are able to print on paper or electronically save this ERSD for your future reference and access; or (ii) that you are able to email this ERSD to an email address where you will be able to print on paper or save it for your future reference and access. Further, if you consent to receiving notices and disclosures exclusively in electronic format as described herein, then select the check-box next to ‘I agree to use electronic records and signatures’ before clicking ‘CONTINUE’ within the DocuSign system.

By selecting the check-box next to ‘I agree to use electronic records and signatures’, you confirm that:

- You can access and read this Electronic Record and Signature Disclosure; and
- You can print on paper this Electronic Record and Signature Disclosure, or save or send this Electronic Record and Disclosure to a location where you can print it, for future reference and access; and
- Until or unless you notify City of Ocala - Procurement & Contracting as described above, you consent to receive exclusively through electronic means all notices, disclosures, authorizations, acknowledgements, and other documents that are required to be provided or made available to you by City of Ocala - Procurement & Contracting during the course of your relationship with City of Ocala - Procurement & Contracting.