

OCALA ELECTRIC UTILITY
OCALA, FLORIDA

FIRST REVISED SHEET NO. 19.0
CANCELS ORIGINAL SHEET NO. 19.0

**APPLICATION FOR INTERCONNECTION OF
CUSTOMER-OWNED RENEWABLE
GENERATION SYSTEMS**

- TIER 1 - Ten (10) kW or Less
- TIER 2 - Greater than 10 kW and Less Than or Equal to 100 kW
- TIER 3 - Greater than 100 kW and Less Than or Equal to Two (2) MW

Note: These customer-owned renewable generation system size limits may be subject to a cumulative enrollment limit on net-metering customers located in the area served by the City of Ocala Electric Utility. Please refer to the Ocala Electric Utility Net-Metering Rate Schedule.

Ocala Electric Utility customers who install customer-owned renewable generation systems (RGS) and desire to interconnect those facilities with the Ocala Electric Utility system are required to complete this application. When the completed application and fees are returned to Ocala Electric Utility, the process of completing the appropriate Tier 1, Tier 2 or Tier 3 Interconnection Agreement can begin. This application and copies of the Interconnection Agreements may be obtained at Ocala Electric Utility, located at 201 SE 3rd Street, Ocala, Florida 34471, or may be requested by email from OEU@ocalafl.org.

1. Customer Information

Name: Mark Rothermel
 Mailing Address: 6245 NE 60th St
 City: Silver Springs State: FL Zip Code: 34488
 Phone Number: 407-595-3985 Alternate Phone Number: _____
 Email Address: Rothny96@yahoo.com Fax Number: _____
 Ocala Electric Utility Customer Account Number: 542213-123458

2. RGS Facility Information

Facility Location: 6245 NE 60th St, Silver Springs FL 34488
 Ocala Electric Utility Customer Account Number: 542213-123458
 RGS Manufacturer: Duracell (micro inverters) Mission Solar (modules)
 Manufacturer's Address: Duracell (unit 18A+18B, Orchard Industrial Estate, Eversham Rd, Toddington, Cheltenham, GL54 5EB, United Kingdom, Mission Solar 8303 S New Braunfels Ave, San Antonio, TX 78235
 Reference or Model Number: Duracell - D700 M2 Mission - MSE PERC 66 395
 Serial Number: Too many to list

(Continued on Sheet No.19.1)

Issued by: Michael Poucher, P.E.
Electric Utility Director

Effective: October 1, 2019

OCALA ELECTRIC UTILITY
OCALA, FLORIDA
(Continue from Sheet No. 19.0)

FIRST REVISED SHEET NO. 19.1
CANCELS ORIGINAL SHEET NO. 19.1

3. Facility Rating Information

Gross Power Rating: 10.41kw_{ac} ("Gross power rating" means the total manufacturer's AC nameplate generating capacity of an on-site customer-owned renewable generation system that will be interconnected to and operate in parallel with Ocala Electric Utility's distribution facilities. For inverter-based systems, the AC nameplate generating capacity shall be calculated by multiplying the total installed DC nameplate generating capacity by 0.85 in order to account for losses during the conversion from DC to AC.)

Fuel or Energy Source: Photovoltaic

Anticipated In- Service Date: 8/30/2024

4. Application Fee

The application fee is based on the Gross Power Rating and must be submitted with this application. The non-refundable application fee is \$375 for Tier 2 and \$750 for Tier 3 installations. There is no application fee for Tier 1 installations.

5. Interconnection Study Fee

For Tier 3 installations, a deposit in the amount of the estimated costs of the study (to be determined at time of application) must be paid along with this application in addition to the application fee referenced in Article 4 above. This deposit will be applied toward the cost of an interconnection study. The customer will be responsible for the actual costs of the study. Should the actual cost of the study be less than the deposit, the difference will be refunded to the customer. Customer agrees to comply with all interconnection requirements identified in the interconnection study report.

6. Required Documentation

Prior to completion of the Interconnection Agreement, the following information must be provided to the Ocala Electric Utility by the customer.

- A. Documentation demonstrating that the installation complies with (or most current version at time of inspection approval):
1. IEEE 1547 (2018) Standard for Interconnecting Distributed Resources with Electric Power Systems.
 2. IEEE 1547.1 (2005) Standard Conformance Test Procedures for Equipment Interconnecting Distributed Resources with Electric Power Systems.
 3. UL 1741 (2010) Inverters, Converters, Controllers and Interconnection System Equipment for Use with Distributed Energy Resources.

(Continued on Sheet No. 19.2)

Issued by: Michael Poucher, P.E.
Electric Utility Director

Effective: October 1, 2019

OCALA ELECTRIC UTILITY
OCALA, FLORIDA
(Continued from Sheet No. 19.1)

FIRST REVISED SHEET NO. 19.2
CANCELS ORIGINAL SHEET NO. 19.2

B. Documentation that the customer-owned renewable generation has been inspected and approved by local code officials prior to its operation in parallel with the Ocala Electric Utility system to ensure compliance with applicable local codes. OEU will also require proof of commission testing by a qualified 3rd party testing company (not affiliated in any way with the manufacturer, vendor or installation contractor), for compliance with all required and applicable codes, standards, and interconnection study requirements, prior to setting of OEU metering equipment.

C. Proof of insurance in the amount of:
Tier 1 - \$100,000.00
Tier 2 - \$1,000,000.00
Tier 3 - \$2,000,000.00

Customer

By: Mark Rothermel Date: 5/1/2024
(Print Name)

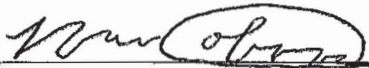
(Signature)

OCALA ELECTRIC UTILITY
OCALA, FLORIDA

FIRST REVISED SHEET NO. 20.0
CANCELS ORIGINAL SHEET NO. 20.0

Tri-Party Net-Metering Power Purchase Agreement

This Tri-Party Net-Metering Power Purchase Agreement (this "Agreement") is entered into this 1 day of May, 2024, by and between the Florida Municipal Power Agency, a governmental joint action agency created and existing under the laws of the State of Florida (hereinafter "FMPA"), the City of Ocala doing business as Ocala Electric Utility, a body politic (hereinafter "OEU"), and Mark Rothermel, a retail electric customer of OEU (hereinafter "Customer").

Section 1. Recitals

1.01. OEU and Customer have executed OEU's Standard Interconnection Agreement for a Customer-Owned Renewable Generation System (RGS) pursuant to which OEU has agreed to permit interconnection of Customer's renewable generation to OEU's electric system at Customer's presently-metered location, and Customer has agreed to deliver excess electric energy generated by Customer's Renewable Generation System to OEU's electric distribution system;

1.02. The City of Ocala and FMPA have entered into the All-Requirements Power Supply Contract, dated as of May 1, 1986, (hereinafter the "ARP Contract") pursuant to which the City of Ocala has agreed to purchase and receive, and FMPA has agreed to sell and supply OEU with all energy and capacity necessary to operate the OEU electric system, which limits OEU's ability to directly purchase excess energy from customer-owned renewable generation.

1.03. In order to promote the development of small customer-owned renewable generation by permitting OEU to allow its customers to interconnect with OEU's electric system and to allow OEU's electric customers to offset their electric consumption with customer-owned renewable generation, FMPA, in accordance with the terms and conditions of this agreement, has agreed to purchase excess customer-owned generation from OEU's electric customers interconnected to OEU's electric system.

NOW THEREFORE, for and in consideration of the mutual covenants and agreements set forth herein, the Parties covenant and agree as follows:

Section 2. Interconnection

2.01. Customer shall not begin parallel operations with the OEU electric distribution system until Customer has executed OEU's electric Standard Interconnection Agreement for Small Customer-Owned Renewable Generation and is in compliance with all terms and conditions

OEU requires that the customer install and operate the RGS in accordance with all applicable safety codes and standards. OEU shall establish and enforce terms and conditions of operation and disconnection of all interconnected customer-owned renewable generation as it relates to the effect of the RGS on OEU's electric distribution system.

(Continued on Sheet No. 20.1)

Issued by: Michael Poucher, P.E.
Electric Utility Director

Effective: October 1, 2019

OCALA ELECTRIC UTILITY
OCALA, FLORIDA
(Continued from Sheet No. 20.0)

FIRST REVISED SHEET NO. 20.1
CANCELS ORIGINAL SHEET NO. 20.1

Section 3. Metering

3.01 In accordance with the OEU's Standard Interconnection Agreement for Customer-Owned Renewable Generation, OEU shall install metering equipment at the point of delivery capable of recording two separate kWh meter readings: (1) the flow of electricity from OEU to the Customer (Delivered), and (2) the flow of excess electricity from the Customer to OEU. OEU shall take meter readings on the same cycle as the otherwise applicable rate schedule.

Section 4. Purchase of Excess Customer-Owned Renewable Generation

4.01. Customer-owned renewable generation shall be first used for Customer's own load and shall offset Customer's demand for OEU's electricity. All electric power and energy delivered by OEU to Customer shall be received and paid for by Customer to OEU (Received) pursuant to the terms, conditions and rates of the OEU otherwise applicable rate schedule.

4.02. Excess customer-owned renewable generation shall be delivered to the OEU Electric distribution system. For purposes of this Agreement, the term "excess customer-owned renewable generation" means any kWh of electrical energy produced by the customer-owned renewable generation system that is not consumed by Customer and is delivered to the OEU electric distribution system. FMPA agrees to purchase and receive, and Customer agrees to sell and deliver, all excess customer-owned renewable generation at the energy rate established by FMPA, which shall be calculated in accordance with Schedule A. Excess customer-owned renewable generation shall be purchased in the form of a credit on Customer's monthly energy consumption bill from OEU.

4.03. In the event that a given monthly credit for excess customer-owned renewable generation exceeds the total billed amount for Customer's consumption in any corresponding month, then the excess credit shall be applied to the subsequent month's bill. Excess energy credits produced pursuant to the preceding sentence shall accumulate and be used to offset Customer's energy consumption bill for a period of not more than twelve (12) months. At the end of each calendar year, any unused excess energy credits shall be paid by OEU to the Customer in accordance with the OEU Electric Net-Metering Service Rate Schedule.

(Continued on Sheet No. 20.2)

Issued by: Michael Poucher, P.E.
Electric Utility Director

Effective: October 1, 2019

OCALA ELECTRIC UTILITY
OCALA, FLORIDA
(Continued from Sheet No. 20.1)

FIRST REVISED SHEET NO. 20.2
CANCELS ORIGINAL SHEET NO. 20.2

4.04. FMPA and OEU shall not be required to purchase or receive excess customer-owned renewable generation, and may require Customer to interrupt or reduce production of customer-owned renewable generation, (a) when necessary in order to construct, install, maintain, repair, replace, remove, investigate, or inspect any OEU equipment or part of OEU's system; or (b) if either FMPA or OEU determine, in their sole judgment, that curtailment, interruption, or reduction is necessary because of emergencies, forced outages, force majeure, or compliance with any applicable electric code or standard.

4.05. Customer acknowledges that its provision of electricity to OEU hereunder is on a first-offered, first-accepted basis and subject to diminution and/or rejection in the event the total amount of electricity delivered to OEU pursuant to the Net-Metering Service Rate Schedule (as filed with the Florida Public Service Commission), from all participating OEU customers, exceeds two and one-half percent (2.5%) of the aggregate customer peak demand on the OEU electric system.

Section 5. Renewable Energy Credits

5.01. Customer shall offer FMPA a first right of refusal before selling or granting to any third party the right to the Green Attributes associated with its customer-owned renewable generation that is interconnected to OEU electric distribution system. The term "Green Attributes" shall include any and all credits, certificates, benefits, environmental attributes, emissions reductions, offsets, and allowances, however entitled, attributable to the generation of electricity from the customer-owned-renewable generation and its displacement of conventional energy generation.

5.02. Any additional meter(s) installed to measure total renewable electricity generated by the Customer for the purposes of measuring Green Attributes, including and renewable energy certificates (or similarly titled credits for renewable energy generated), shall be installed at the expense of the Customer, unless determined otherwise during negotiations for the sale of the Customer's credits to FMPA.

Section 6. Term and Termination

6.01. This Agreement shall become effective upon execution by all Parties, and shall remain in effect thereafter on a month-to-month basis until terminated by any Party upon thirty (30) days written notice to all other Parties.

6.02. This Agreement shall terminate immediately and without notice upon: (a) termination of the electric distribution service by OEU or (b) failure by Customer to comply with any of the terms and conditions of this Agreement or OEU's Standard Interconnection Agreement for Customer-Owned Renewable Generation.

(Continued on Sheet No. 20.3)

Issued by: Michael Poucher, P.E.
Electric Utility Director

Effective: October 1, 2019

OCALA ELECTRIC UTILITY
OCALA, FLORIDA
(Continued from Sheet No. 20.2)

FIRST REVISED SHEET NO. 20.3
CANCELS ORIGINAL SHEET NO. 20.3

Section 7. Miscellaneous Provisions

7.01. Assignment. It is understood and agreed that no party may transfer, sell, mortgage, pledge, hypothecate, convey, designate, or otherwise assign this Agreement, or any interest herein or any rights or obligations hereunder, in whole or in part, either voluntarily or by operation of law, (including, without limitation, by merger, consolidation, or otherwise), without the express written consent of the other parties (and any such attempt shall be void), which consent shall not be unreasonably withheld. Subject to the foregoing, this Agreement shall inure to the benefit of and be binding upon the parties and their respective successors and permitted assigns.

7.02. Amendment. It is understood and agreed that FMPA and OEU reserve the right, on no less than an annual basis, to change any of the terms and conditions, including pricing, in this Agreement on sixty (60) days advance written notice. FMPA and OEU may make such changes on an immediate basis in the event any applicable law, rule, regulation or court order requires them. In such event, FMPA and OEU will give Customer as much notice as reasonably possible under the circumstances.

7.03. Indemnification. To the fullest extent permitted by laws and regulations, and in return for adequate, separate consideration, Customer shall defend, indemnify, and hold harmless FMPA and OEU, their officers, directors, agents, guests, invitees, and employees from and against all claims, damages, losses to persons or property, whether direct, indirect, or consequential (including but not limited to fees and charges of attorneys, and other professionals and court and arbitration costs) arising out of, resulting from, occasioned by, or otherwise caused by the operation or misoperation of the customer-owned renewable generation, or the acts or omissions of any other person or organization directly or indirectly employed by the Customer to install, furnish, repair, replace or maintain the customer-owned renewable generation system, or anyone for whose acts any of them may be liable.

7.04. Governing Law. The validity and interpretation of this Agreement and the rights and obligations of the parties shall be governed and construed in accordance with the laws of the State of Florida without regard for any conflicts of law provisions that might cause the law of other jurisdictions to apply. All controversies, claims, or disputes arising out of or related to this Agreement or any agreement, instrument, or document contemplated hereby, shall be brought exclusively in the County or Circuit Court for Marion County, Florida, or the United States District Court sitting in Marion County, Florida, as appropriate.

(Continued on Sheet No. 20.4)

Issued by: Michael Poucher, P.E.
Electric Utility Director

Effective: October 1, 2019

OCALA ELECTRIC UTILITY
OCALA, FLORIDA
(Continued from Sheet No. 20.3)

FIRST REVISED SHEET NO. 20.4
CANCELS ORIGINAL SHEET NO. 20.4

7.05. Enforcement of Agreement. In the event that either party is required to enforce this Agreement by court proceedings or otherwise, the prevailing party shall be entitled to recover all fees and costs incurred, including reasonable attorney's fees and costs for trial, alternative dispute resolution, and/or appellate proceedings.

7.06. Severability. To the extent any provision of this Agreement is prohibited by or invalid under applicable law, such provision shall be ineffective to the extent of such prohibition or invalidity, without invalidating the remainder of such provision or the remaining provisions of this Agreement.

7.07. Third Party Beneficiaries and Sovereign Immunity. This Agreement is solely for the benefit of FMPA, OEU, and Customer and no right nor shall any cause of action accrue upon or by reason, to or for the benefit of any third party not a formal party to this Agreement. Nothing in this Agreement, expressed or implied, is intended or shall be construed to confer upon any person or corporation other than FMPA, OEU, or Customer, any right, remedy, or claim under or by reason of this Agreement or any of the provisions or conditions of this Agreement; and, all provisions, representations, covenants, and conditions contained in this Agreement shall inure to the sole benefit of and be binding upon FMPA, OEU, and Customer and their respective representatives, successors, and assigns. Further, no term or condition contained in this Agreement shall be construed in any way as a waiver by either FMPA or OEU of the sovereign immunity applicable to either or both of them as established by Florida Statutes, 768.28.

(Continued on Sheet No. 20.5)

Issued by: Michael Poucher, P.E.
Electric Utility Director

Effective: October 1, 2019

OCALA ELECTRIC UTILITY
OCALA, FLORIDA
(Continued from Sheet No. 20.4)

FIRST REVISED SHEET NO. 20.5
CANCELS ORIGINAL SHEET NO. 20.5

IN WITNESS WHEREOF, Customer and OEU have executed this Agreement the day and year first above written.

City of Ocala Electric Utility

Florida Municipal Power Agency

By: Signed by: Janice Mitchell
5510BB13858A4E1...
Title: CFO
Date: 11/21/2024

By: DocuSigned by: [Signature]
0B7F58E8B346471...
Title: VP of IT/OT and System Ops
Date: 11/21/2024

Customer
By: MARIA A. [Signature] Date: 10-14-24
(Print Name)
[Signature]
(Signature)

Customer's City of Ocala Electric Utility Account Number: _____

Approved as to form and legality:

DocuSigned by: William E. Sexton
807DFCA488E432...
William E. Sexton, Esq.
City Attorney

(Continued on Sheet No. 20.6)

Issued by: Michael Poucher, P.E.
Electric Utility Director

Effective: October 1, 2019

OCALA ELECTRIC UTILITY
OCALA, FLORIDA
(Continued from Sheet No. 20.5)

FIRST REVISED SHEET NO. 20.6
CANCELS ORIGINAL SHEET NO. 20.6

**Tri-Party Net-Metering Power Purchase Agreement
Schedule A**

I. All-Requirements Project Calculation of Excess Customer-Owned Renewable Generation Credit

- a) FMPA shall pay OEU for the excess kWh energy delivered by customer-owned renewable generation to OEU's electric system. Every month, OEU shall determine the total kWh of customer-owned renewable generation that is delivered to OEU's electric system, and shall send the information to FMPA as soon as it becomes available, but no later than the second working day of every month. FMPA will then provide a monthly payment to OEU in the form of a credit on the ARP power bill for the excess energy delivered to the distribution grid. The ARP Renewable Generation Credit will be calculated as follows:

ARP Renewable Generation Credit = Quarterly Energy Rate * Monthly kWh of excess customer-owned renewable generation

Quarterly Energy Rate = 3 month average of ARP energy rate. FMPA will update the Quarterly Energy Rate every April 1, July 1, October 1 and January 1.

- b) As part of the monthly bill adjustment, FMPA will also increase OEU's kWh billing amount by the same kWh amount as the customer-owned renewable generation purchased by FMPA. This adjustment is necessary because excess customer generation that flows onto OEU's electric system has been purchased by FMPA, but will remain on OEU's electric system and be used by OEU to meet its other customers' electric needs. As a result, OEU's monthly ARP bill will be adjusted accordingly to reflect FMPA's subsequent sale of this energy to OEU.

II. Payment for Unused Excess Energy Credits

- a) Monthly excess energy credits shall accumulate and be used to offset the Customer's following month energy consumption bill for a period of not more than twelve (12) months.
- b) At the end of each calendar year, OEU shall pay the Customer for any unused excess energy credits in accordance with the OEU Electric Net-Metering Service Rate Schedule.

Issued by: Michael Poucher, P.E.
Electric Utility Director

Effective: October 1, 2019

OCALA ELECTRIC UTILITY
OCALA, FLORIDA

FIRST REVISED SHEET NO. 22.0
CANCELS ORIGINAL SHEET NO. 22.0

Tier 2
Standard Interconnection Agreement
Customer-Owned Renewable Generation System

This Agreement is made and entered into this 1 day of May, 2024, by and between Mark Rothermel, (hereinafter called "Customer"), located at 6245 NE 60th St in Silver Springs, Florida, and the City of Ocala doing business as Ocala Electric Utility (hereafter called "OEU"), a body politic. Customer and OEU shall collectively be called the "Parties". The physical location/premise where the interconnection is taking place: 6245 NE 60th St.

WITNESSETH

Whereas, a Tier 2 Renewable Generation System (RGS) is an electric generating system that uses one or of more of the following fuels or energy sources: hydrogen, biomass, solar energy, geothermal energy, wind energy, ocean energy, waste heat, or hydroelectric power as defined in Section 377.803, Florida Statutes, rated at more than 10 kilowatts (10 kW) but not greater than 100 kilowatts (100 kW) alternating current (AC) power output and is primarily intended to offset part or all of the customer's current electric requirements; and

Whereas, OEU operates an electric system serving parts of the City of Ocala and Marion County; and

Whereas, Customer has made a written Application to OEU, a copy being attached hereto, to interconnect its RGS with OEU's electrical supply grid at the location indentified above; and

Whereas, the City of Ocala and the Florida Municipal Power Agency (hereinafter called "FMPA") have entered into the All-Requirements Power Supply Contract pursuant to which OEU has agreed to purchase and receive, and FMPA has agreed to sell and supply OEU with all energy and capacity necessary to operate OEU's electric system, which limits OEU's ability to directly purchase excess energy from customer-owned renewable generation; and

Whereas, in order to promote the development of small customer-owned renewable generation by permitting OEU to allow its customers to interconnect with OEU's electric system and to allow OEU customers to offset their electric consumption with customer-owned renewable generation, FMPA, in accordance with the terms and conditions of this agreement, has agreed to purchase excess customer-owned generation from OEU customers interconnected to OEU's electric system; and

Whereas, OEU desires to provide interconnection of a RGS under conditions which will insure the safety of OEU customers and employees, reliability and integrity of its distribution system;

(Continued on Sheet No. 22.1)

Issued by: Michael Poucher, P.E.
Electric Utility Director

Effective: October 1, 2019

OCALA ELECTRIC UTILITY
OCALA, FLORIDA
(Continued from Sheet No. 22.0)

FIRST REVISED SHEET NO. 22.1
CANCELS ORIGINAL SHEET NO. 22.1

NOW, THEREFORE, for and in consideration of the mutual covenants and agreements herein set forth, the parties hereto covenant and agree as follows:

1. The Customer shall be required to enter into a Tri-Party Net-Metering Purchase Power Agreement with FMPA and OEU.
2. "Gross power rating" (GPR) means the total manufacturer's AC nameplate generating capacity of an on-site customer-owned renewable generation system that will be interconnected to and operate in parallel with OEU distribution facilities. For inverter-based systems, the GPR shall be calculated by multiplying the total installed DC nameplate generating capacity by 0.85 in order to account for losses during the conversion from DC to AC.
3. This agreement is strictly limited to cover a Tier 2 RGS as defined above. It is the Customer's responsibility to notify OEU of any change to the GPR of the RGS by submitting a new application for interconnection specifying the modifications at least 30 days prior to making the modifications. In no case should modifications to the RGS be made such that the GPR increases above the 100 kilowatts (100 kW) limit.
4. The RGS GPR must not exceed 90 percent (90%) of the Customer's OEU calculated distribution service rating at the Customer's location (including shared electric facilities). If the GPR does exceed the 90 percent (90%) limit, the Customer shall be responsible to pay the cost of upgrades to the distribution facilities required to accommodate the GPR capacity and ensure the 90 percent (90%) threshold is not breached. OEU will not allow a RGS GPR greater than required to offset the customer's annual kWh energy consumption (based on customer's historical consumption data or by means of estimated usage of similar type of service as determined by OEU).
5. The Customer shall be required to pay a non-refundable application fee of \$375 for the review and processing of the application.
6. The Customer shall fully comply with OEU's Rules and Regulations and Electric Service Specifications as those documents may be amended or revised by OEU from time to time.
7. The Customer certifies that its installation, its operation and its maintenance shall be in compliance with the following standards (or most current version at time of inspection approval):
 - a. IEEE-1547 (2018) Standard for Interconnecting Distributed Resources with Electric Power System;
 - b. IEEE-1547.1 (2005) Standard Conformance Test Procedures for Equipment Interconnection Distributed Resources with Electric Power Systems;
 - c. UL-1741 (2010) Inverters, Converters, Controllers and Interconnection System Equipment for Use with Distributed *Energy Resources*.

(Continued on Sheet No. 22.2)

Issued by: Michael Poucher, P.E.
Electric Utility Director

Effective: October 1, 2019

OCALA ELECTRIC UTILITY
OCALA, FLORIDA
(Continued from Sheet No. 22.1)

FIRST REVISED SHEET NO. 22.2
CANCELS ORIGINAL SHEET NO. 22.2

- d. The National Electric Code, state and/or local building codes, mechanical codes and/or electrical codes;
 - e. The manufacturer's installation, operation and maintenance instructions.
8. The Customer is not precluded from contracting for the lease, operation or maintenance of the RGS with a third party. Such lease may not provide terms or conditions that provide for any payments under the agreement to any way indicate or reflect the purchase of energy produced by the RGS. Customer shall not enter into any lease agreement that results in the retail purchase of electricity; or the retail sale of electricity from the customer-owned renewable generation. Notwithstanding this restriction, in the event that Customer is determined to have engaged in the retail purchase of electricity from a party other than OEU, then Customer shall be in breach of this Agreement and may be subject to the jurisdiction of the Florida Public Service Commission and to fines/penalties.
9. The Customer shall provide a copy of the manufacturer's installation, operation and maintenance instructions to OEU. If the RGS is leased to the Customer by a third party, or if the operation or maintenance of the RGS is to be performed by a third party, the lease and/or maintenance agreements and any pertinent documents related to these agreements shall be provided to OEU.
10. Prior to commencing parallel operation with OEU's electric system, Customer shall have the RGS inspected and approved by the appropriate code authorities having jurisdiction. Customer shall provide a copy of this inspection and approval to OEU.
11. The Customer agrees to permit OEU, if it should so choose, to inspect the RGS and its component equipment and the documents necessary to ensure compliance with this Agreement both before and after the RGS goes into service and to witness the initial testing of the RGS equipment and protective apparatus. OEU will provide Customer with as much notice as reasonably possible, either in writing, email, facsimile or by phone as to when OEU may conduct inspections and or document review. Upon reasonable notice, or at any time without notice in the event of an emergency or hazardous condition, Customer agrees to provide OEU access to the Customer's premises for any purpose in connection with the performance of the obligations required by this Agreement or, if necessary, to meet OEU's legal obligation to provide service to its customers. At least ten (10) business days prior to initially placing the customer-owned renewable generation system in service, Customer shall provide written notification to OEU advising OEU of the date and time at which Customer intends to place the system in service, and OEU shall have the right to have personnel present on the in-service date in order to ensure compliance with the requirements of this Agreement.

(Continued on Sheet No. 22.3)

Issued by: Michael Poucher, P.E.
Electric Utility Director

Effective: October 1, 2019

OCALA ELECTRIC UTILITY
OCALA, FLORIDA
(Continued from Sheet No. 22.2)

FIRST REVISED SHEET NO. 22.3
CANCELS ORIGINAL SHEET NO. 22.3

12. The Customer's RGS must have an appropriately sized grid-tie inverter system that includes applicable protective systems. Customer certifies that the RGS equipment includes a utility-interactive inverter or interconnection system equipment that ceases to interconnect with the OEU system upon a loss of OEU power. The inverter shall be considered certified for interconnected operation if it has been submitted by a manufacturer to a nationally recognized testing laboratory (NRTL) to comply with UL 1741. The NRTL shall be approved by the Occupational Safety & Health Administration (OSHA).

13. If Customer adds another RGS which (i) utilizes the same utility-interactive inverter for both systems; or (ii) utilizes a separate utility-interactive inverter for each system, then Customer shall provide OEU with sixty (60) days advance written notice of the addition.

14. The Customer shall not energize the OEU system when OEU's system is deenergized. The Customer shall cease to energize the OEU system during a faulted condition on the OEU system and/or upon any notice from OEU that the deenergizing of Customer's RGS equipment is necessary. The Customer shall cease to energize the OEU system prior to automatic or non-automatic reclosing of OEU's protective devices. There shall be no intentional islanding, as described in IEEE 1547, between the Customer's and OEU's systems.

15. The Customer is responsible for the protection of its generation equipment, inverters, protection devices, and other system components from damage from the normal and abnormal operations that occur on OEU's electric system in delivering and restoring system power. Customer agrees that any damage to any of its property, including, without limitation, all components and related accessories of its RGS system, due to the normal or abnormal operation of OEU's electric system, is at Customer's sole risk and expense. Customer is also responsible for ensuring that the customer-owned renewable generation equipment is inspected, maintained, and tested regularly in accordance with the manufacturer's instructions to ensure that it is operating correctly and safely.

16. The Customer must install, at their expense, a manual disconnect switch of the visible load break type to provide a separation point between the AC power output of the customer-owned renewable generation system and any Customer wiring connected to OEU's electric system such that back feed from the customer-owned renewable generation system to OEU's electric system cannot occur when the switch is in the open position. The manual disconnect switch shall be mounted separate from the meter socket on an exterior surface adjacent to the meter. The switch shall be readily accessible to OEU and capable of being locked in the open position with an OEU padlock. When locked and tagged in the open position by OEU, this switch will be under the control of OEU.

(Continued on Sheet No. 22.4)

Issued by: Michael Poucher, P.E.
Electric Utility Director

Effective: October 1, 2019

OCALA ELECTRIC UTILITY
OCALA, FLORIDA
(Continued from Sheet No. 22.3)

FIRST REVISED SHEET NO. 22.4
CANCELS ORIGINAL SHEET NO. 22.4

17. Subject to an approved inspection, including installation of acceptable disconnect switch, this Agreement shall be executed by OEU within thirty (30) calendar days of receipt of a completed application. Customer must execute this Agreement and return it to OEU at least thirty (30) calendar days prior to beginning parallel operations with OEU's electric system, subject to the requirements of Sections 18 and 19, below, and within one (1) year after OEU executes this Agreement.

18. Once OEU has received Customer's written documentation that the requirements of this Agreement have been met, all agreements and documentation have been received and the correct operation of the manual switch has been demonstrated to an OEU representative, OEU will, within fifteen (15) business days, send written notice that parallel operation of the RGS may commence.

19. OEU requires the Customer to maintain general liability insurance for personal injury and property damage in the amount of not less than one million dollars (\$1,000,000.00).

20. OEU will furnish, install, own and maintain metering equipment capable of measuring the flow of kilowatt-hours (kWh) of energy. The Customer's service associated with the RGS will be metered to measure the energy delivered by OEU to Customer, and also measure the energy delivered by Customer to OEU. Customer agrees to provide safe and reasonable access to the premises for installation, maintenance and reading of the metering and related equipment. The Customer shall not be responsible for the cost of the installation and maintenance of the metering equipment necessary to measure the energy delivered by the Customer to OEU.

21. The Customer shall be solely responsible for all legal and financial obligations arising from the design, construction, installation, operation, maintenance and ownership of the RGS.

22. The Customer must obtain all permits, inspections and approvals required by applicable jurisdictions with respect to the generating system and must use a licensed, bonded and insured contractor to design and install the generating system. The Customer agrees to provide OEU with a copy of the local building code official inspection and certification of installation. The certification shall reflect that the local code official has inspected and certified that the installation was permitted, has been approved, and has met all electrical and mechanical qualifications.

23. In no event shall any statement, representation, or lack thereof, either express or implied, by OEU, relieve the Customer of exclusive responsibility for the Customer's system. Specifically, any OUS inspection of the RGS shall not be construed as confirming or endorsing the system design or its operating or maintenance procedures or as a warranty or guarantee as to the safety, reliability, or durability of the RGS. OEU's inspection, acceptance, or its failure to inspect shall not be deemed an endorsement of any RGS equipment or procedure. Further, as set forth in Sections 15 and 26 of this Agreement, Customer shall remain solely responsible for any and all losses, claims, damages and/or expenses related in any way to the operation or misoperation of its RGS equipment.

(Continued on Sheet No. 22.5)

Issued by: Michael Poucher, P.E.
Electric Utility Director

Effective: October 1, 2019

OCALA ELECTRIC UTILITY
OCALA, FLORIDA
(Continued from Sheet No. 22.4)

FIRST REVISED SHEET NO. 22.5
CANCELS ORIGINAL SHEET NO. 22.5

24. Notwithstanding any other provision of this Interconnection Agreement, OEU, at its sole and absolute discretion, may isolate the Customer's system from the distribution grid by whatever means necessary, without prior notice to the Customer. To the extent practical, however, prior notice shall be given. The system will be reconnected as soon as practical once the conditions causing the disconnection cease to exist. OEU shall have no obligation to compensate the Customer for any loss of energy during any and all periods when Customer's RGS is operating at reduced capacity or is disconnected from OEU's electrical distribution system pursuant to this Interconnection Agreement. Typical conditions which may require the disconnection of the Customer's system include, but are not limited to, the following:

- a. OEU utility system emergencies, forced outages, uncontrollable forces or compliance with prudent electric utility practice.
- b. When necessary to investigate, inspect, construct, install, maintain, repair, replace or remove any OEU equipment, any part of OEU's electrical distribution system or Customer's generating system.
- c. Hazardous conditions existing on OEU's utility system due to the operation of the Customer's generation or protective equipment as determined by OEU.
- d. Adverse electrical effects (such as power quality problems) on the electrical equipment of OEU's other electric consumers caused by the Customer's generation as determined by OEU.
- e. When Customer is in breach of any of its obligations under this Interconnection Agreement or any other applicable policies and procedures of OEU.
- f. When the Customer fails to make any payments due to OEU by the due date thereof.

25. Upon termination of services pursuant to this Agreement, OEU shall open and padlock the manual disconnect switch and remove any additional metering equipment related to this Agreement. At the Customer's expense, within thirty (30) working days following the termination, the Customer shall permanently isolate the RGS and any associated equipment from OEU's electric supply system, notify OEU that the isolation is complete, and coordinate with OEU for return of OEU's lock.

26. To the fullest extent permitted by law, and in return for adequate, separate consideration, Customer shall indemnify, defend and hold harmless OEU, any and all of their members of its governing bodies, and its officers, agents, and employees for, from and against any and all claims, demands, suits, costs of defense, attorneys' fees, witness fees of any type, losses, damages, expenses, and liabilities, whether direct, indirect or consequential, related to, arising from, or in any way connected with:

- a. Customer's design, construction, installation, inspection, maintenance, testing or operation of Customer's generating system or equipment used in connection with this Interconnection Agreement, irrespective of any fault on the part of OEU.

(Continued on Sheet No. 22.6)

Issued by: Michael Poucher, P.E.
Electric Utility Director

Effective: October 1, 2019

OCALA ELECTRIC UTILITY
OCALA, FLORIDA
(Continued from Sheet No. 22.5)

FIRST REVISED SHEET NO. 22.6
CANCELS ORIGINAL SHEET NO. 22.6

- b. The interconnection of Customer's generating system with, and delivery of energy from the generating system to, OEU's electrical distribution system, irrespective of any fault on the part of OEU.
- c. The performance or nonperformance of Customer's obligations under this Interconnection Agreement or the obligations of any and all of the members of Customer's governing bodies and its officers, contractors (and any subcontractor or material supplier thereof), agents and employees.

Customer's obligations under this Section shall survive the termination of this Interconnection Agreement.

27. Customer shall not have the right to assign its benefits or obligations under this Agreement without OEU's prior written consent and such consent shall not be unreasonably withheld. If there is a change in ownership of the RGS, Customer shall provide written notice to OEU at least thirty (30) days prior to the change in ownership. The new owner will be required to assume, in writing, the Customer's rights and duties under this Agreement, or execute a new Standard Interconnection Agreement. The new owner shall not be permitted to net meter or begin parallel operations until the new owner assumes this Agreement or executes a new Agreement.

28. This Agreement supersedes all previous agreements and representations either written or verbal heretofore made between OEU and Customer with respect to matters herein contained. This Agreement, when duly executed, constitutes the only Agreement between parties hereto relative to the matters herein described. This Agreement shall continue in effect from year to year until either party gives sixty (60) days notice of its intent to terminate this Agreement.

29. This Agreement shall be governed by and construed and enforced in accordance with the laws, rules and regulations of the State of Florida and OEU's tariff as it may be modified, changed, or amended from time to time, including any amendments modification or changes to OEU's Net-Metering Service Rate Schedule, the schedule applicable to this Agreement. The Customer and OEU agree that any action, suit, or proceeding arising out of or relating to this Interconnection Agreement shall be initiated and prosecuted in the state court of competent jurisdiction located in Marion County, Florida, and OEU and the Customer irrevocably submit to the jurisdiction and venue of such court. To the fullest extent permitted by law, each Party hereby irrevocably waives any and all rights to a trial by jury and covenants and agrees that it will not request a trial by jury with respect to any legal proceeding arising out of or relating to this Interconnection Agreement.

None of the provisions of this Interconnection Agreement shall be considered waived by either Party except when such waiver is given in writing. No waiver by either Party of any one or more defaults in the performance of the provisions of this Interconnection Agreement shall operate or be construed as a waiver of any other existing or future default or defaults. If any one or more of the provisions of this Interconnection Agreement or the applicability of any provision to a

(Continued on Sheet No. 22.7)

Issued by: Michael Poucher, P.E.
Electric Utility Director

Effective: October 1, 2019

OCALA ELECTRIC UTILITY
OCALA, FLORIDA
(Continued from Sheet No. 22.6)

FIRST REVISED SHEET NO. 22.7
CANCELS ORIGINAL SHEET NO. 22.7

specific situation is held invalid or unenforceable, the provision shall be modified to the minimum extent necessary to make it or its application valid and enforceable, and the validity and enforceability of all other provisions of this Interconnection and all other applications of such provisions shall not be affected by any such invalidity or unenforceability. This Interconnection Agreement does not govern the terms and conditions for the delivery of power and energy to non-generating retail customers of OEU's electrical distribution system.

30. This Agreement incorporates by reference the terms of the tariff filed with the Florida Public Service Commission by OEU, including OEU's Net-Metering Service Rate Schedule, and associated technical terms and abbreviations, general rules and regulations and standard electric service requirements (as may be applicable) are incorporated by reference, as amended from time to time. To the extent of any conflict between this Agreement and such tariff, the tariff shall control.

31. OEU and Customer recognize that the Florida Statutes and/or the Florida Public Service Commission Rules, including those directly addressing the subject of this Agreement, may be amended from time to time. In the event that such statutes and/or rules are amended that affect the terms and conditions of this Agreement, OEU and Customer agree to supersede and replace this Agreement with a new Interconnection Agreement which complies with the amended statutes/rules.

32. Customer acknowledges that its provision of electricity to OEU hereunder is on a first-offered first-accepted basis and subject to diminution and/or rejection in the event the total amount of electricity delivered to OEU pursuant to the OEU's Net-Metering Service Rate Schedule (as filed with the Florida Public Service Commission), from all participating OEU customers, exceeds 2.5 percent (%) of the aggregate customer peak demand on OEU's electric system.

33. This Agreement is solely for the benefit of OEU and Customer and no right nor any cause of action shall accrue upon or by reason, to or for the benefit of any third party not a formal party to this Agreement. Nothing in this Agreement, expressed or implied, is intended or shall be construed to confer upon any person or corporation other than OEU or Customer, any right, remedy, or claim under or by reason of this Agreement or any of the provisions or conditions of this Agreement; and, all provisions, representations, covenants, and conditions contained in this Agreement shall inure to the sole benefit of and be binding upon OEU and Customer and their respective representatives, successors, and assigns. Further, no term or condition contained in this Agreement shall be construed in any way as a waiver by OEU of the sovereign immunity applicable to OEU as established by Florida Statutes, 768.28.

(Continued on Sheet No. 22.8)

Issued by: Michael Poucher, P.E.
Electric Utility Director

Effective: October 1, 2019

OCALA ELECTRIC UTILITY
OCALA, FLORIDA
(Continued from Sheet No. 22.7)

FIRST REVISED SHEET NO. 22.8
CANCELS ORIGINAL SHEET NO. 22.8

IN WITNESS WHEREOF, Customer and OEU have executed this Agreement the day and year first above written.

OUS:

Customer:

By: Signed by:
Janice Mitchell

By: Mark Rothermel
(Print Name)

Title: CFO

(Signature)

Date: 11/21/2024

Date: 5/1/24

City of Ocala Electric Utility Account Number:
542213-123458

Approved as to form and legality:

DocuSigned by:
William E. Sexton
William E. Sexton, Esq.
City Attorney

NEW

Renewal of Number

POLICY DECLARATIONS

No. **XPL2639683**

Mount Vernon Fire Insurance Company

1190 Devon Park Drive, Wayne, Pennsylvania 19087

A Member Company of United States Liability Insurance Group

NAMED INSURED AND ADDRESS:

**MARK AND LENA ROTHERMEL
6245 NE 60TH ST
SILVER SPRINGS, FL 34488**

THIS INSURANCE IS ISSUED PURSUANT TO THE FLORIDA SURPLUS LINES LAW. PERSONS INSURED BY SURPLUS LINES CARRIERS DO NOT HAVE THE PROTECTION OF THE FLORIDA INSURANCE GUARANTY ACT TO THE EXTENT OF ANY RIGHT OF RECOVERY FOR THE OBLIGATION OF AN INSOLVENT UNLICENSED INSURER.

SURPLUS LINES INSURERS POLICY RATES AND FORMS ARE NOT APPROVED BY ANY FLORIDA REGULATORY AGENCY.

POLICY PERIOD: (MO. DAY YR.) From: 09/06/2024 To: 09/06/2025

12:01 A.M. STANDARD TIME AT YOUR MAILING ADDRESS SHOWN ABOVE

ENTITY: Husband And Wife

IN RETURN FOR THE PAYMENT OF THE PREMIUM, AND SUBJECT TO ALL THE TERMS OF THIS POLICY, WE AGREE WITH YOU TO PROVIDE THE INSURANCE AS STATED IN THIS POLICY.

THIS POLICY CONSISTS OF THE FOLLOWING COVERAGE PARTS FOR WHICH A PREMIUM IS INDICATED.

	PREMIUM
Excess Comprehensive Personal Liability Coverage	\$516.00
Wholesaler Broker Fee	\$50.00
Service Fee	\$0.34
Surplus Lines Tax	\$27.96
TOTAL:	\$594.30

Coverage Form(s) and Endorsement(s) made a part of this policy at time of issue

See Endorsement EOD (1/95)

Agent: **RELIANCE RISK SOLUTIONS (5594)**
PO Box 800
Oak Ridge, TN 37831

Issued: **09/10/2024 9:43 AM**

Broker: Brightway Insurance
1500 Alafaya Trail Suite 1012
Oviedo, FL 32765

By:  Authorized Representative

THESE DECLARATIONS TOGETHER WITH THE COMMON POLICY CONDITIONS, COVERAGE PART DECLARATIONS, COVERAGE PART COVERAGE FORM(S) AND FORMS AND ENDORSEMENTS, IF ANY, ISSUED TO FORM A PART THEREOF, COMPLETE THE ABOVE NUMBERED POLICY.

EXCESS COMPREHENSIVE PERSONAL LIABILITY COVERAGE DECLARATIONS	
Policy No. XPL2639683	Effective Date: 09/06/2024 12:01 AM STANDARD TIME
LIMITS OF INSURANCE	
Company's Limits of Insurance	\$700,000
Underlying Limits of Insurance	\$300,000
SELF INSURED RETENTION	
	\$0
LOCATION OF COVERAGE	
<i>Location</i>	<i>Address</i>
1	6245 Ne 60Th St, Silver Springs, FL 34488
SCHEDULE OF UNDERLYING INSURANCE ATTACHED	
Coverage Form(s)/Part(s) and Endorsement(s) made a part of this policy at time of issue: See Form EOD (01/95)	
THESE DECLARATIONS ARE PART OF THE POLICY DECLARATIONS CONTAINING THE NAME OF THE INSURED AND THE POLICY PERIOD.	



CONTRACTOR INFORMATION:
 NEXT DIMENSION SOLAR LLC
 13624 US 441
 SUMMERFIELD FL 34491
 LICENSE# EC-13012679

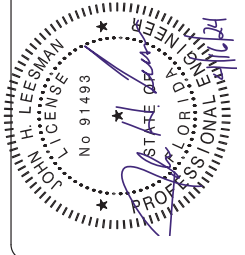

SITE INFORMATION
 MARK ROTHERMEL
 6245 NE 60TH ST
 SILVER SPRINGS, FL 34488
 AC SYSTEM SIZE: 11.136 KW AC
 DC SYSTEM SIZE: 12.245 KW DC
 LAT, 29.2492529 LONG, -82.04752
 (31) MISSION SOLAR MSEPERC66-395
 (16) D700-M2

OCALA ELECTRIC UTILITY

DRAWN BY: SoloCAD
 4/12/2024
 LINE DIAGRAM - PV05

TAG	CONDUCTOR DETAILS	GROUND DETAILS	CONDUIT SIZE
1	(2) 12-2 PV-WIRE, USE 2 COPPER	(1) 6 AWG BARE COPPER	N/A - FREE AIR
2	(8) 10 AWG THHN/THWN-2 COPPER	(1) 10 AWG THHN/THWN-2 COPPER	3/4" EMT
3	(3) 6 AWG THWN-2 COPPER	(1) 8 AWG THWN-2 COPPER	3/4" EMT

John H Leesman, Professional Engineer, State of Florida
 License No. 91493
 This item has been digitally signed and sealed by John H. Leesman, PE on 04-16-2024.
 Printed copies of this document are not considered signed and sealed and the signature must be verified on any electronic copies.

EQUIPMENT SCHEDULE	
PV MODULES: (31)	MSEPERC66-395
INVERTERS: (16)	D700-M2
AC DISCONNECT(S): (1)	PV AC DISCONNECT, 240V, 2-POLE
AC COMBINER: (1)	AC COMBINER

MSEPERC66-395 SPECS		D700-M2 SPECS	
POWER MAX (PMAX):	395 W	MAX INPUT VOLTAGE:	60 V
OPEN CIRCUIT VOLTAGE (VOC):	45.18 V	MAX DC SHORT CIRCUIT CURRENT:	12 A
MAX POWER-POINT CURRENT (IMPP):	10.68 A	MAXIMUM OUTPUT POWER:	696 W
MAX POWER-POINT VOLTAGE (VMPP):	36.99 V	MAXIMUM OUTPUT CURRENT:	2.9 A
SHORT CIRCUIT CURRENT (ISC):	11.24 A	NOM. OUTPUT VOLTAGE:	240 V
SERIES FUSE RATING:	20 A	1-PHASE, 60 Hz, UL 1741 LISTED	

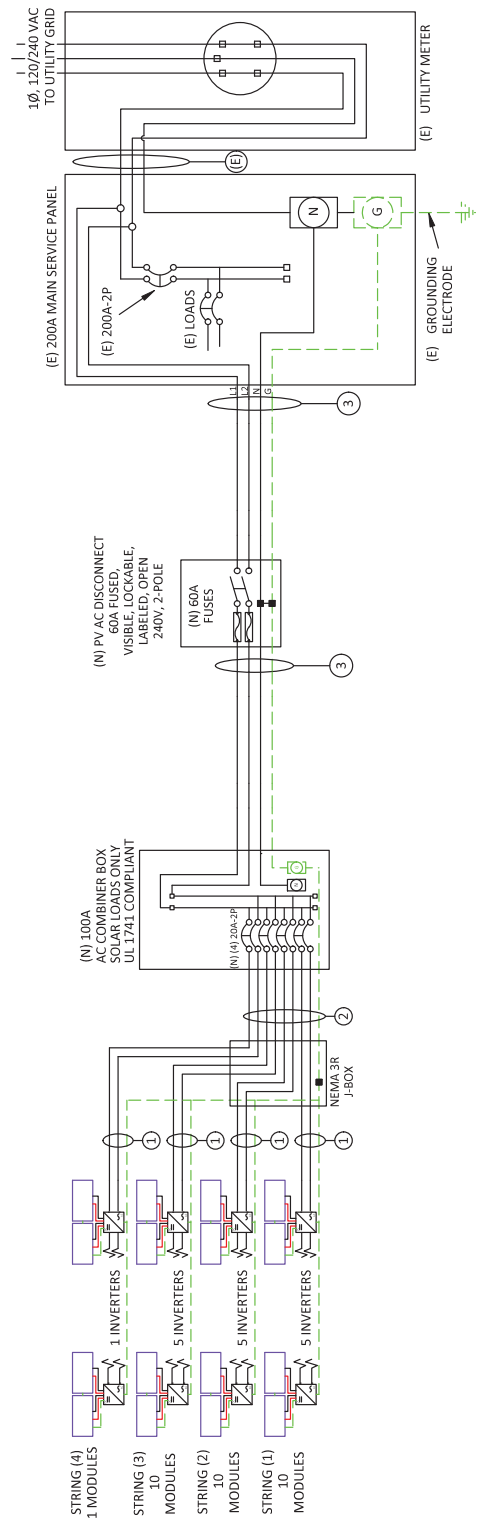

VISIBLE, LOCKABLE, LABELED AC DISCONNECT LOCATED WITHIN 10' OF UTILITY METER

SUPPLY SIDE CONNECTION
 NEC 230.46, NEC 230.79 & NEC 705.11



CONTRACTOR INFORMATION:
 NEXT DIMENSION SOLAR LLC
 13624 US 441
 SUMMERFIELD FL 34491
 LICENSE# EC-13012679

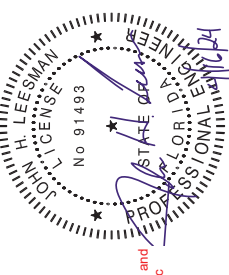

SITE INFORMATION
 MARK ROTHERMEL
 6245 NE 60TH ST
 SILVER SPRINGS, FL 34488
 AC SYSTEM SIZE: 11.136 KW AC
 DC SYSTEM SIZE: 12.245 KW DC
 LAT, 29.2492529 LONG, -82.04752
 (31) MISSION SOLAR MSEPERC66-395
 (16) D700-M2

Ocala Electric Utility
 DRAWN BY: SoloCAD
 4/12/2024
 SITE PLAN - PV02

ARRAY DETAILS:

MOUNTING PLANE:	AZIMUTH:	TILT:
MP1	180°	23°
MP2	0°	23°

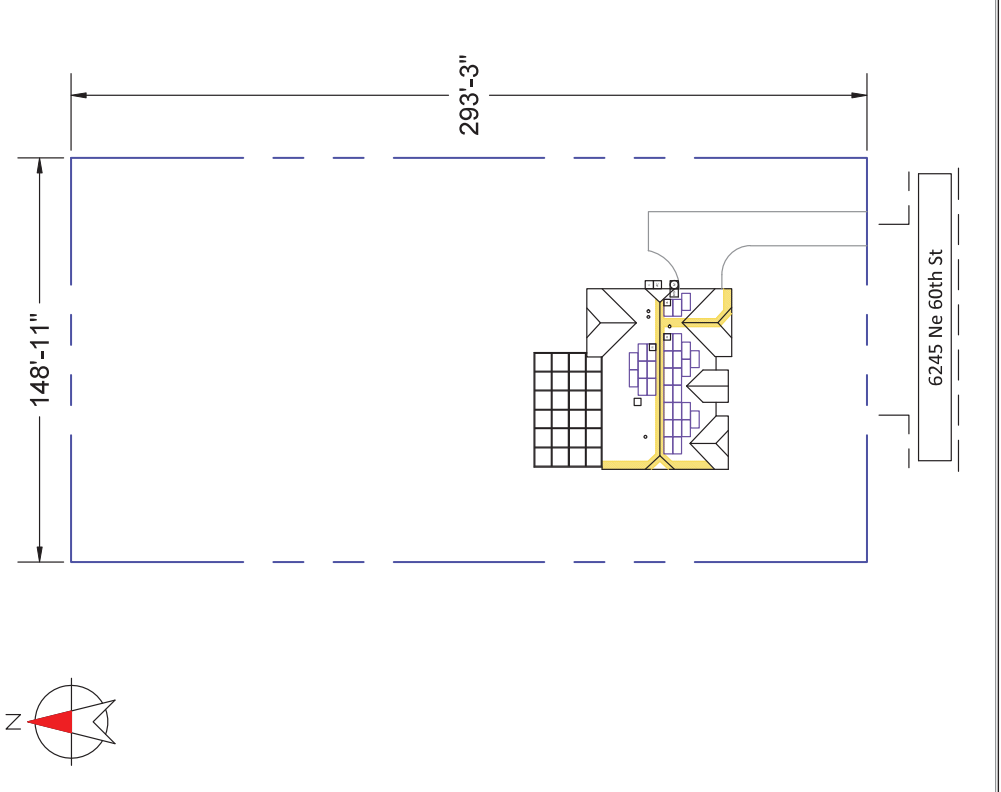
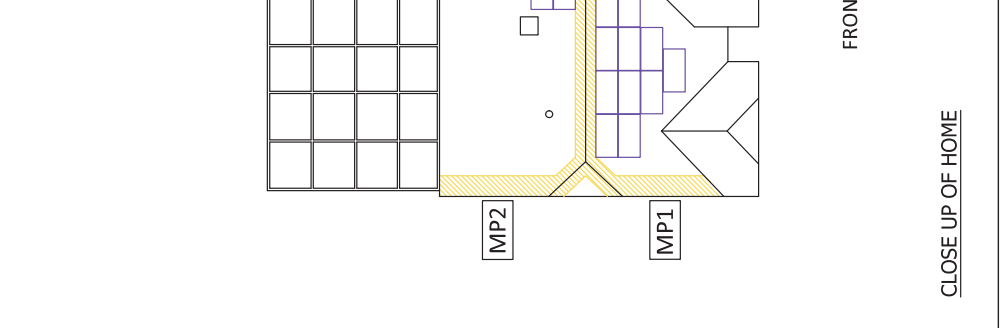

VISIBLE, LOCKABLE, LABELED
 AC DISCONNECT LOCATED
 WITHIN 10' OF UTILITY METER

EQUIPMENT LEGEND:

- UTILITY METER
- MAIN SERVICE PANEL
- AC DISCONNECT
- METER SOCKET (FOR UTILITY PV METER)
- SUB PANEL
- LOAD CENTER
- INVERTER
- COMBINER BOX
- SERVICE DISCONNECT
- BATTERY(IES)
- PV MODULES
- JUNCTION BOX
- PROPERTY LINE
- FIRE ACCESS PATHWAY (3' TYP)

VISIBLE, LOCKABLE, LABELED
 AC DISCONNECT
 METER SOCKET
 (FOR UTILITY PV METER)

UTILITY METER

MAIN SERVICE PANEL

AC DISCONNECT

METER SOCKET
(FOR UTILITY PV METER)

SUB PANEL

LOAD CENTER

INVERTER

COMBINER BOX

SERVICE DISCONNECT

BATTERY(IES)

PV MODULES

JUNCTION BOX

PROPERTY LINE

FIRE ACCESS PATHWAY (3' TYP)

DURACELL
POWER CENTER

Solar PV Microinverters
D350-M1 / D700-M2 / D1500-M4



Single

Dual

Quad

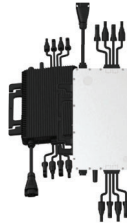

Fast, Easy & Flexible Installation

Duracell Power Center's family of single, dual, and quad microinverters delivers the lowest cost, highest yield per panel PV installation.

The AC trunk cable format permits any combination of the three models to optimize even the most complex rooftop installations.

Reactive Power Control
CA Rule 21 compliant

Compliant with U.S.
NEC-2017 & NEC-2020
690.12 rapid shutdown

High reliability: NEMA 6
(IP67) enclosure, 6000V
surge protection

Become a Duracell Partner Today

sales@duracellpowercenter.com

DURACELL
POWER CENTER

Solar PV Microinverters
D350-M1 / D700-M2 / D1500-M4

Technical Data

Model	D350-M1	D700-M2	D1500-M4
Input Data (DC)			
Number of PV inputs	1	2	4
Module power range, typical (W)	280 to 470+	280 to 470+	300 to 505+
Maximum input voltage (V)	60	60	60
MPPT voltage range (V)	16-60	16-60	16-60
Start-up voltage (V)	22	22	22
Maximum input current (A)	11.5	11.5	11.5
Output Data (AC)			
Peak output power (VA)	350	700	1500
Maximum continuous output power (VA)	349	696	1438
Maximum continuous output current (A)	1.45	2.9	3.35
Nominal output voltage (V)	240	240	240
Nominal output voltage range (V)	211-264	211-264	211-264
Nominal frequency/range (Hz)	60/55-65	60/55-65	60/55-65
Power factor (adjustable)	>0.99 default (0.8 lead to 0.8 lag)	>0.99 default (0.8 lead to 0.8 lag)	>0.99 default (0.8 lead to 0.8 lag)
Total harmonic distortion	<3%	<3%	<3%
Maximum units per branch (10 AWG)	16	8	4
Efficiency			
CEC peak efficiency (%)	96.7	96.7	96.7
CEC weighted efficiency (%)	96.5	96.5	96.5
Nominal MPPT efficiency (%)	99.8	99.8	99.8
Nighttime power consumption (mW)	-50	-50	-50
Mechanical Data			
Ambient temperature range (°C)	-40 to +65	-40 to +65	-40 to +65
Dimensions (W x H x D) mm	182 x 164 x 29.5	250 x 170 x 28	280 x 176 x 33
Weight (kg)	1.75	2.6	3.35
Enclosure rating	Outdoor NEMA 6	Outdoor NEMA 6	Outdoor NEMA 6
Cooling	Natural convection - no fans	Natural convection - no fans	Natural convection - no fans
Features			
Communication	2.4 GHz proprietary RF (Nordic)	2.4 GHz proprietary RF (Nordic)	2.4 GHz proprietary RF (Nordic)
Monitoring	Yes	Yes	Yes
Warranty	Up to 25 years	Up to 25 years	Up to 25 years
Compliance	UL 1741, IEEE 1547, UL 1741 SA (240Vac), CA Rule 21 (240Vac), CSA C22.2 No. 107.1-16, FCC Part 15B, FCC Part 15C	UL 1741, IEEE 1547, UL 1741 SA (240Vac), CA Rule 21 (240Vac), CSA C22.2 No. 107.1-16, FCC Part 15B, FCC Part 15C	UL 1741, IEEE 1547, UL 1741 SA (240Vac), CA Rule 21 (240Vac), CSA C22.2 No. 107.1-16, FCC Part 15B, FCC Part 15C
PV Rapid Shutdown	Comforms with NEC-2017 and NEC-2020 Article 690.12 and CEC-2021 Sec 64-218	Comforms with NEC-2017 and NEC-2020 Article 690.12 and CEC-2021 Sec 64-218	Comforms with NEC-2017 and NEC-2020 Article 690.12 and CEC-2021 Sec 64-218

*1. Nominal voltage/frequency range can vary depending on local requirements.
*2. Refer to local requirements for exact number of microinverters per branch.

©2022 Power Center
Duracell is a registered trademark of Duracell U.S. Operations, Inc., used under license. All rights reserved.



MSE PERC 66

395W

Class leading power output -0 to +3%

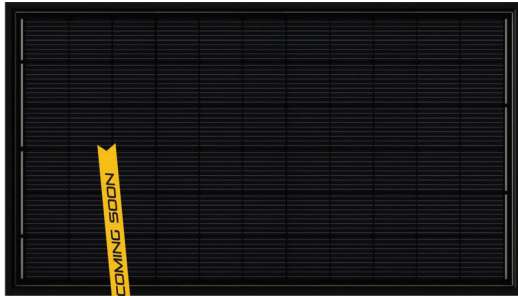

COMING SOON

True American Quality True American Brand

Mission Solar Energy is headquartered in San Antonio, Texas where we manufacture our modules. We produce American, high-quality solar modules ensuring the highest-in-class power output and best-in-class reliability. Our product line is tailored for residential, commercial and utility applications. Every Mission Solar Energy solar module is certified and surpasses industry standard regulations, proving excellent performance over the long term.

Demand the best. Demand Mission Solar Energy.



Certified Reliability

- Meets UL 6170 & IEC Standards
• Proven performance
• Resistance to salt mist corrosion



Advanced Technology

- 9-Barrier Emitter Rear Contact
• Ideal for all applications



Extreme Weather Resilience

- Up to 5,400 Pa front load & 3,600 Pa back load
• Resistant to UL 61730
• 40mm frame



BAA Compliant for Government Projects

- Buy American Act
• American Recovery & Reinvestment Act



If you have questions regarding the certification of our products in your area, contact us at info@missionsolar.com. Mission Solar Energy.

CERTIFICATIONS



UL 61730 / IEC 61215 / IEC 61730 / IEC 61701

C-5A2-MKTG-0027 REV.4 03/18/2022

www.missionsolar.com | info@missionsolar.com

Class Leading 395-395W

MSE PERC 66

BASIC DIMENSIONS (UNITS: MM/IN)

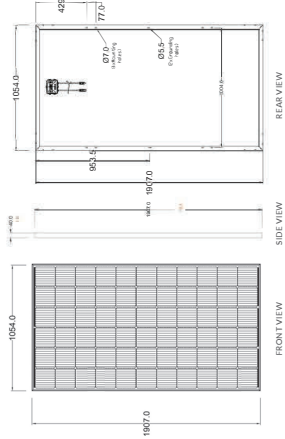
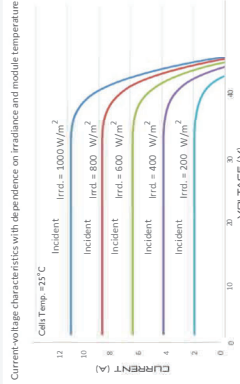

Table with 2 columns: ELECTRICAL SPECIFICATION and PRODUCT TYPE. Rows include Power Output, Module Efficiency, Short Circuit Current, Open Circuit Voltage, Rated Current, Rated Voltage, Fuse Rating, System Voltage.

Table with 2 columns: TEMPERATURE COEFFICIENTS and OPERATING CONDITIONS. Rows include Normal Operating Cell Temperature, Temperature Coefficient of Pmax, Temperature Coefficient of Voc, Temperature Coefficient of Isc, Maximum System Voltage, Operating Temperature Range, Maximum Series Fuse Rating, Fire Safety Classification, Front & Back Load, Front & Back Load, Hal Safety Impact Velocity.

CURRENT-VOLTAGE CURVE MSE385X9R, 385WP, 66 CELL SOLAR MODULE



CERTIFICATIONS AND TESTS

IEC 61215, 61730, 61701



Mission Solar Energy

8303 S. New Braunfels Ave., San Antonio, Texas 78235 www.missionsolar.com | info@missionsolar.com

Mission Solar Energy reserves the right to make specification changes without notice. C-5A2-MKTG-0027 REV.4 03/18/2022

www.missionsolar.com | info@missionsolar.com

C-5A2-MKTG-0027 REV.4 03/18/2022

Certificate Of Completion

Envelope Id: FC1561D7-C665-47FB-88F4-5528E000A1CB
 Subject: FOR SIGNATURE: Net-Metering Agreement - Mark Roethermel (ELE/250184)
 Source Envelope:
 Document Pages: 25
 Certificate Pages: 5
 AutoNav: Enabled
 Envelopeld Stamping: Enabled
 Time Zone: (UTC-05:00) Eastern Time (US & Canada)

Status: Completed
 Envelope Originator:
 April Adolf
 110 SE Watula Avenue
 City Hall, Third Floor
 Ocala, FL 34471
 aadolf@ocalafl.gov
 IP Address: 216.255.240.104

Record Tracking

Status: Original
 11/15/2024 9:04:51 PM
 Security Appliance Status: Connected
 Storage Appliance Status: Connected

Holder: April Adolf
 aadolf@ocalafl.gov
 Pool: StateLocal
 Pool: City of Ocala - Procurement & Contracting

Location: DocuSign
 Location: DocuSign

Signer Events

William E. Sexton
 wsexton@ocalafl.org
 City Attorney
 City of Ocala
 Security Level: Email, Account Authentication
 (None)

Signature

DocuSigned by:

 B07DCFC4E86E429...
 Signature Adoption: Pre-selected Style
 Using IP Address: 216.255.240.104

Timestamp

Sent: 11/15/2024 9:11:35 PM
 Viewed: 11/19/2024 10:17:50 AM
 Signed: 11/19/2024 10:18:33 AM

Electronic Record and Signature Disclosure: Not Offered via DocuSign

Janice Mitchell
 jmitchell@Ocalafl.org
 CFO
 City of Ocala
 Security Level: Email, Account Authentication
 (None)

Signed by:

 55198B43858A4E1...
 Signature Adoption: Pre-selected Style
 Using IP Address: 216.255.240.104

Sent: 11/19/2024 10:18:35 AM
 Viewed: 11/21/2024 3:04:51 PM
 Signed: 11/21/2024 3:05:26 PM

Electronic Record and Signature Disclosure: Accepted: 11/21/2024 3:04:51 PM ID: 42a90569-f7e2-41a0-bca6-68fe72c76777

Chris Gowder
 chris.gowder@fmpa.com
 VP of IT/OT and System Ops
 Security Level: Email, Account Authentication
 (None)

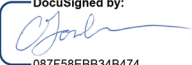
DocuSigned by:

 087F58EBB34B474...
 Signature Adoption: Uploaded Signature Image
 Using IP Address: 38.77.131.2

Sent: 11/21/2024 3:05:29 PM
 Viewed: 11/21/2024 3:28:28 PM
 Signed: 11/21/2024 3:28:35 PM

Electronic Record and Signature Disclosure: Accepted: 11/21/2024 3:28:28 PM ID: f37a7fa2-46d4-4b7b-a0e5-8d36bc1b20f0

In Person Signer Events	Signature	Timestamp
Editor Delivery Events	Status	Timestamp
Agent Delivery Events	Status	Timestamp
Intermediary Delivery Events	Status	Timestamp

Certified Delivery Events	Status	Timestamp
----------------------------------	---------------	------------------

Carbon Copy Events	Status	Timestamp
---------------------------	---------------	------------------

Witness Events	Signature	Timestamp
-----------------------	------------------	------------------

Notary Events	Signature	Timestamp
----------------------	------------------	------------------

Envelope Summary Events	Status	Timestamps
--------------------------------	---------------	-------------------

Envelope Sent	Hashed/Encrypted	11/15/2024 9:11:36 PM
Certified Delivered	Security Checked	11/21/2024 3:28:28 PM
Signing Complete	Security Checked	11/21/2024 3:28:35 PM
Completed	Security Checked	11/21/2024 3:28:35 PM

Payment Events	Status	Timestamps
-----------------------	---------------	-------------------

Electronic Record and Signature Disclosure

ELECTRONIC RECORD AND SIGNATURE DISCLOSURE

From time to time, City of Ocala - Procurement & Contracting (we, us or Company) may be required by law to provide to you certain written notices or disclosures. Described below are the terms and conditions for providing to you such notices and disclosures electronically through the DocuSign system. Please read the information below carefully and thoroughly, and if you can access this information electronically to your satisfaction and agree to this Electronic Record and Signature Disclosure (ERSD), please confirm your agreement by selecting the check-box next to 'I agree to use electronic records and signatures' before clicking 'CONTINUE' within the DocuSign system.

Getting paper copies

At any time, you may request from us a paper copy of any record provided or made available electronically to you by us. You will have the ability to download and print documents we send to you through the DocuSign system during and immediately after the signing session and, if you elect to create a DocuSign account, you may access the documents for a limited period of time (usually 30 days) after such documents are first sent to you. After such time, if you wish for us to send you paper copies of any such documents from our office to you, you will be charged a \$0.00 per-page fee. You may request delivery of such paper copies from us by following the procedure described below.

Withdrawing your consent

If you decide to receive notices and disclosures from us electronically, you may at any time change your mind and tell us that thereafter you want to receive required notices and disclosures only in paper format. How you must inform us of your decision to receive future notices and disclosure in paper format and withdraw your consent to receive notices and disclosures electronically is described below.

Consequences of changing your mind

If you elect to receive required notices and disclosures only in paper format, it will slow the speed at which we can complete certain steps in transactions with you and delivering services to you because we will need first to send the required notices or disclosures to you in paper format, and then wait until we receive back from you your acknowledgment of your receipt of such paper notices or disclosures. Further, you will no longer be able to use the DocuSign system to receive required notices and consents electronically from us or to sign electronically documents from us.

All notices and disclosures will be sent to you electronically

Unless you tell us otherwise in accordance with the procedures described herein, we will provide electronically to you through the DocuSign system all required notices, disclosures, authorizations, acknowledgements, and other documents that are required to be provided or made available to you during the course of our relationship with you. To reduce the chance of you inadvertently not receiving any notice or disclosure, we prefer to provide all of the required notices and disclosures to you by the same method and to the same address that you have given us. Thus, you can receive all the disclosures and notices electronically or in paper format through the paper mail delivery system. If you do not agree with this process, please let us know as described below. Please also see the paragraph immediately above that describes the consequences of your electing not to receive delivery of the notices and disclosures electronically from us.

How to contact City of Ocala - Procurement & Contracting:

You may contact us to let us know of your changes as to how we may contact you electronically, to request paper copies of certain information from us, and to withdraw your prior consent to receive notices and disclosures electronically as follows:

To contact us by email send messages to: contracts@ocalafl.org

To advise City of Ocala - Procurement & Contracting of your new email address

To let us know of a change in your email address where we should send notices and disclosures electronically to you, you must send an email message to us at contracts@ocalafl.org and in the body of such request you must state: your previous email address, your new email address. We do not require any other information from you to change your email address.

If you created a DocuSign account, you may update it with your new email address through your account preferences.

To request paper copies from City of Ocala - Procurement & Contracting

To request delivery from us of paper copies of the notices and disclosures previously provided by us to you electronically, you must send us an email to contracts@ocalafl.org and in the body of such request you must state your email address, full name, mailing address, and telephone number. We will bill you for any fees at that time, if any.

To withdraw your consent with City of Ocala - Procurement & Contracting

To inform us that you no longer wish to receive future notices and disclosures in electronic format you may:

- i. decline to sign a document from within your signing session, and on the subsequent page, select the check-box indicating you wish to withdraw your consent, or you may;
- ii. send us an email to contracts@ocalafl.org and in the body of such request you must state your email, full name, mailing address, and telephone number. We do not need any other information from you to withdraw consent.. The consequences of your withdrawing consent for online documents will be that transactions may take a longer time to process..

Required hardware and software

The minimum system requirements for using the DocuSign system may change over time. The current system requirements are found here: <https://support.docusign.com/guides/signer-guide-signing-system-requirements>.

Acknowledging your access and consent to receive and sign documents electronically

To confirm to us that you can access this information electronically, which will be similar to other electronic notices and disclosures that we will provide to you, please confirm that you have read this ERSD, and (i) that you are able to print on paper or electronically save this ERSD for your future reference and access; or (ii) that you are able to email this ERSD to an email address where you will be able to print on paper or save it for your future reference and access. Further, if you consent to receiving notices and disclosures exclusively in electronic format as described herein, then select the check-box next to ‘I agree to use electronic records and signatures’ before clicking ‘CONTINUE’ within the DocuSign system.

By selecting the check-box next to ‘I agree to use electronic records and signatures’, you confirm that:

- You can access and read this Electronic Record and Signature Disclosure; and
- You can print on paper this Electronic Record and Signature Disclosure, or save or send this Electronic Record and Disclosure to a location where you can print it, for future reference and access; and
- Until or unless you notify City of Ocala - Procurement & Contracting as described above, you consent to receive exclusively through electronic means all notices, disclosures, authorizations, acknowledgements, and other documents that are required to be provided or made available to you by City of Ocala - Procurement & Contracting during the course of your relationship with City of Ocala - Procurement & Contracting.